

Firestop Submittal Package

Project:

Date:

Submitted by:

*This submittal is auto-generated based on user-selected inputs.
Therefore, Hilti makes no representation as to the suitability of these systems for their intended use.*

Hilti. Outperform. Outlast.



Hilti Firestop
Saving lives
through innovation
and education

Table of Contents

UL Listings

W-L-73241

CFP-ES ENDO-SHIELD

Product data Sheet for CFP-ES ENDO-SHIELD.....3
UL Certificate of Compliance for CFP-ES ENDO-SHIELD.....4
Safety Data Sheet (SDS) for CFP-ES ENDO-SHIELD.....6

CP 606 Firestop acrylic sealant

Product Data Sheet for CP 606 Flexible Firestop Sealant13
UL Certificate of Compliance for CP 606 Flexible Firestop Sealant14
Safety Data Sheet (SDS) for CP 606 Flexible Firestop Sealant.....15
LEED Information for CP 606 Flexible Firestop Sealant22

CP 618 Firestop putty stick

Product Data Sheet for CP 618 Firestop Putty Stick23
UL Certificate of Compliance for CP 618 Firestop Putty Stick.....24
Safety Data Sheet (SDS) for CP 617 Firestop Putty Pad, Cp 618 Putty Stick, and CP 619T
Putty Roll, CFS-D 1", CFS-D 25.....25
VOC Emissions Certificate_CDPH v1.2 2017_CP 61833

FS-ONE MAX Firestop intumescent sealant

Product Data Sheet for FS-ONE MAX Intumescent Firestop Sealant.....34
UL Certificate of Compliance for FS-ONE MAX Intumescent Firestop Sealant.....35
Safety Data Sheet (SDS) for FS-ONE MAX Intumescent Firestop Sealant36
LEED Information for FS-ONE MAX Intumescent Firestop Sealant.....43



Classified by Underwriters Laboratories, Inc. to UL 1479 and CAN/ULC-S115

System No. W-L-7324

WL 7324

ANSI/UL1479 (ASTM E814)	CAN/ULC S115
F Ratings — 1 and 2 Hr (See Item 1)	F Ratings — 1 and 2 Hr (See Item 1)
T Ratings — 1 and 2 Hr (See Item 1)	FT Ratings — 1 and 2 Hr (See Item 1)
	FH Ratings — 1 and 2 Hr (See Item 1)
	FTH Ratings — 1 and 2 Hr (See Item 1)

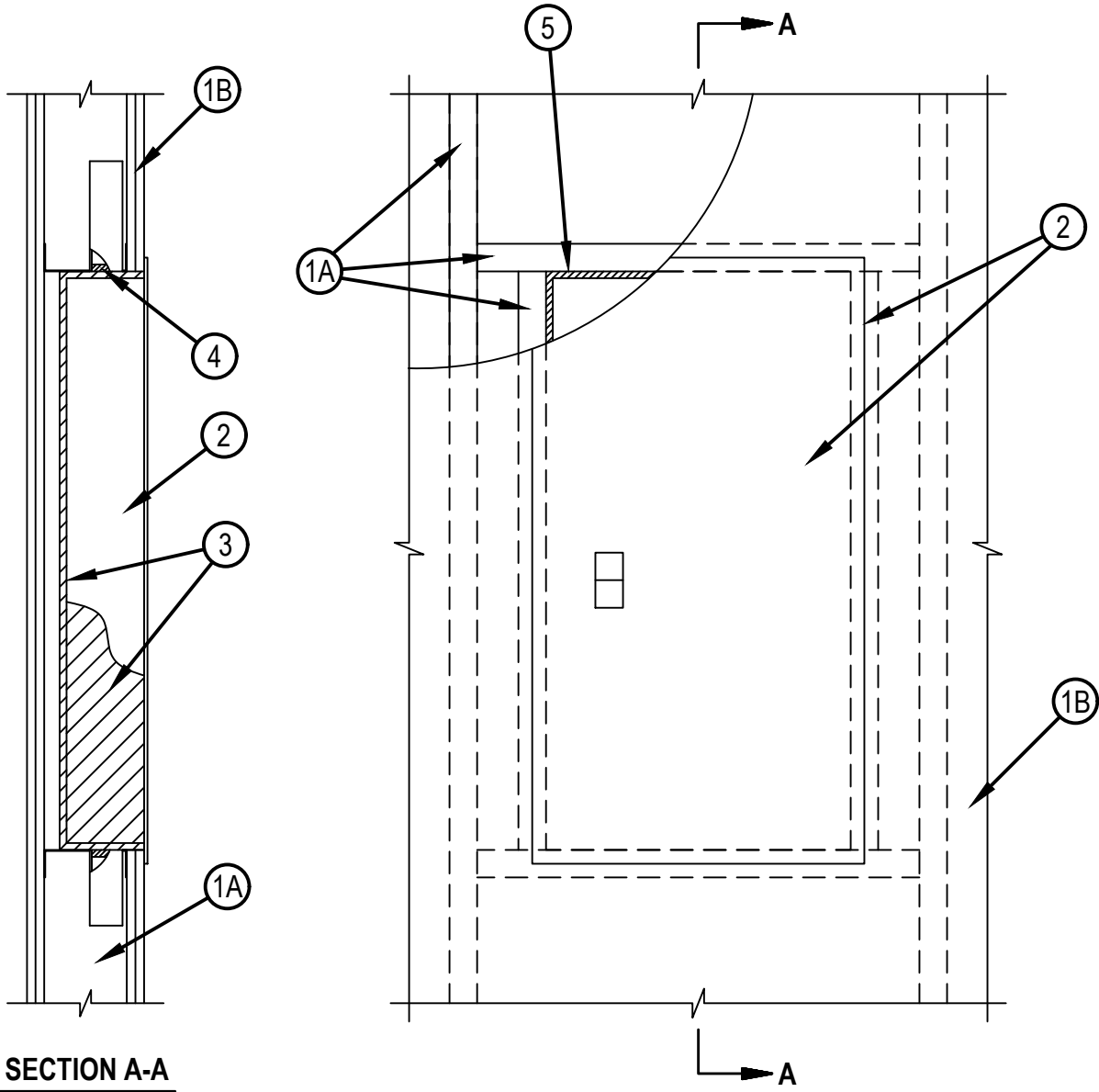

Reproduced by HILTI, Inc. Courtesy of Underwriters Laboratories, Inc. November 15, 2021

System No. W-L-7324

WL 7324

1. Wall Assembly —The 1 or 2 hr fire-rated gypsum board/stud wall assembly shall be constructed of the materials and in the manner described in the individual U400, V400 or W400 Series Wall or Partition Design in the UL Fire Resistance Directory and shall include the following construction features:
 - A. Studs —Wall framing may consist of steel channel studs. Steel studs to be min 3-5/8 in. (92 mm) wide and spaced max 24 in. (610 mm) OC. Additional studs installed horizontally at the top and bottom of the steel box. Additional studs installed vertically as required for steel box attachment.
 - B. Gypsum Board* —Gypsum board type, thickness, number of layers, and orientation shall be as specified in the individual Wall and Partition Design. Size of cutout made to accommodate steel box (Item 2) and wrap material (Item 3).
The hourly Ratings of the firestop system are equal to the hourly fire rating of the wall assembly in which it is installed.
2. Steel Box —Max 14-3/8 in. (365 mm) wide by 39 in. (991 mm) by max 3-7/8 (98 mm) by minimum 20 ga steel electrical panel box, steel utility box, or steel med-gas valve box with hinged steel door and mounting flange. Mounting flange to cover opening in gypsum board. Sides of steel box attached from inside the box to wall framing using steel screws after application of wrap material (Item 3). Top, bottom and/or sides of steel box may be penetrated by maximum twenty (20) total penetrants of nom 1/2 in. (13 mm) to 2 in. (51 mm) diam steel pipe, iron pipe, copper pipe or tube, steel conduit, flexible steel conduit or EMT. Steel conduit connectors may be used at interface with steel box. Open ends of pipes, tubes or conduits which terminate inside the box to be plugged with sealant or putty (Item 4).
3. CFP-ES Endo Shield* —Nom 0.5 in. (13 mm) thick flexible sheet wrap material. One layer sized to cover back and four sides of steel box. At corners of steel box, wrap cut horizontally or vertically, extending from corner of steel box to edge of wrap material. Circular openings made in wrap material to accommodate pipes, tubes or conduits sized max 1/2 in. (13 mm) larger than the outside diameter of the pipe, tube, or conduit. Alternately, where penetrant spacing doesn't allow, wrap may be cut around two or more penetrants not to exceed 1/2 in. (13 mm) annular space between wrap and penetrants. Wrap material folded to maintain contact with back and four sides of steel box. At the corners of the box, wrap material is trimmed at top and bottom so that it is flush with the wrap on the sides and corners are sealed with aluminum foil or FSK tape. As an option, the overhanging material can be folded onto the sides and secured with aluminum foil or FSK tape. As an option, prior to application of wrap material, a bead of construction adhesive may be applied to the back and side of steel box at edge.
HILTI CONSTRUCTION CHEMICALS, DIV OF HILTI INC — CFP-ES Endo Shield
4. Fill, Void or Cavity Materials* — Putty or Sealant —Min 1/2 in. (13 mm) thickness of sealant or putty applied into ends of pipes, tubes or conduits that terminate inside box. Additional putty or sealant to fill circular cutouts made to accommodate pipes, tubes or conduits.
HILTI CONSTRUCTION CHEMICALS, DIV OF HILTI INC — CP 618 Putty, FS-ONE MAX Intumescent Sealant
5. Fill, Void or Cavity Materials* — Sealant —Min 1/4 in. (6 mm) bead of sealant applied over exposed edge of CFP-ES Endo Shield prior to installing mounting flange of steel box (Item 2).
HILTI CONSTRUCTION CHEMICALS, DIV OF HILTI INC — CP 606 Sealant, FS-ONE MAX Intumescent Sealant

* Indicates such products shall bear the UL or cUL Certification Mark for jurisdictions employing the UL or cUL Certification (such as Canada), respectively.

CFP-ES ENDO-SHIELD

Product description

- Hilti Endo-Shield is a high-temperature endothermic mat for passive fire protection of critical cable circuits, fuel lines, communication systems and many other MEP systems. It is the industry's first LBP (Low Bio Persistent) endothermic mat for passive fire protection. LBP materials allow fibers to more easily clear from the lungs compared to ceramic fibers, resulting in a safer non-carcinogenic product for the installer.

Applications for use

- Fire protection of critical infrastructure, circuits and Distributed Antenna Systems which should remain operational under fire conditions
- Fire protection of cables within conduits
- Help protect fuel oil piping from fire — such as for backup generators
- Providing a T-rating for conduit, EMT or pipe penetrations — such as through floors in electrical, data or mechanical rooms
- Fire protection of large membrane penetrations — such as recessed electrical boxes/panels in rated barriers, fire extinguisher cabinets or medical gas box outlet

Advantages

- Faster, easier fire protection — high flexibility and low weight makes Hilti endothermic mat a more efficient solution, especially for small diameter pipes
- Safer jobsites — CFP-ES Hilti Endo-Shield is made using non-carcinogenic LBP fibers, helping to remove a common safety hazard for installers
- Helps to lower total installed cost — this simpler method can translate to help reduce significant labor and time savings on-site compared to traditional fire protection solutions
- Extensive third-party performance verification — tested to ASTM E1725 for circuit integrity, UL1489 for fuel pipe protection and tested in accordance to UL1479 (ASTM E814) for membrane and through penetrations

Installation instructions

- See Hilti Literature or third-party listings for complete application and installation details

Technical Data

Application temperature range	-4 °F to 176 °F (-20°C to 80°C)
Color	Silver
Density	32.6 lb/ft³
Dimension	(L x W) 20 ft. x 2 ft.
Shelf life	Unlimited
Storage and transportation temperature range	-4 °F to 176 °F (-20°C to 80°C)
Thickness	0.5 in.
Weight	54.4 lbs
Tested in accordance with	<ul style="list-style-type: none"> • UL 1489 protection of fuel & oil piping system • ASTM E1725 — circuit protection standard • UL 1479 (ASTM E814) for membrane and through penetrations



Order Information

Designation	Qty per package	Item number
Hilti Endo-Shield CFP-ES	1 roll	2331829

Specified Divisions

Section 07 80 00	Fire and Smoke Protection
Section 07 84 00	Firestopping
Section 26 01 00	Operation & Maintenance of Electrical Systems
Section 27 20 00	Data Communications

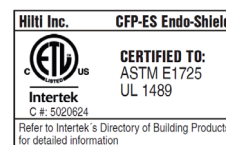
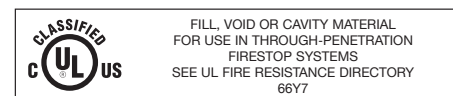

CERTIFICATE OF COMPLIANCE

Certificate Number R13240
Report Reference R13240-20210714
Date 2021-July-23

Issued to: HILTI CONSTRUCTION CHEMICALS, DIV OF HILTI INC
7250 Dallas Pky, Legacy Tower Suite 1000
Plano TX, 75024 US

This is to certify that representative samples of FILL, VOID OR CAVITY MATERIALS
See Addendum Page for Product Designation(s).

Have been investigated by UL in accordance with the Standard(s) indicated on this Certificate.

Standard(s) for Safety: ANSI/UL 1479, Fire Tests of Penetration Firestops
CAN/ULC S115, Standard Method of Fire Tests of Firestop Systems

Additional Information: See the UL Online Certifications Directory at <https://iq.ulprospector.com> for additional information

This Certificate of Compliance does not provide authorization to apply the UL Mark. Only the UL Follow-Up Services Procedure provides authorization to apply the UL Mark.

Only those products bearing the UL Mark should be considered as being UL Certified and covered under UL's Follow-Up Services.

Look for the UL Certification Mark on the product.

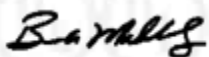

Bruce Mahrenholz, Director North American Certification Program

UL LLC

Any information and documentation involving UL Mark services are provided on behalf of UL LLC (UL) or any authorized licensee of UL. For questions, please contact a local UL Customer Service Representative at <http://ul.com/aboutul/locations/>



CERTIFICATE OF COMPLIANCE

Certificate Number R13240
Report Reference R13240-20210714
Date 2021-July-23

This is to certify that representative samples of the product as specified on this certificate were tested according to the current UL requirements

CFP-ES Endo-Shield for use in specific Through Penetration Firestop Systems published in the Fire Resistance Directory.

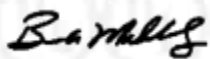

Bruce Mahrenholz, Director North American Certification Program

UL LLC

Any information and documentation involving UL Mark services are provided on behalf of UL LLC (UL) or any authorized licensee of UL. For questions, please contact a local UL Customer Service Representative at <http://ul.com/aboutul/locations/>



CFP-ES Endo-Shield

Safety Data Sheet

A safety data sheet is not required for this product. This Product Safety Information Sheet has been created on a voluntary basis

Issue date: 07/21/2021

Version: 1.0

SECTION 1: Identification

1.1. Identification

Product form	Article
Product name	CFP-ES Endo-Shield
Product code	BU Fire Protection_Safety Information



1.2. Recommended use and restrictions on use

Use of the substance/mixture	Passive fire protection system
------------------------------	--------------------------------

1.3. Supplier

Supplier Hilti, Inc. Legacy Tower, Suite 1000 7250 Dallas Parkway Plano, TX 75024 - USA T +1 9724035800 1-800-879-8000 toll free - F +1 918 254 0522	Department issuing data specification sheet Hilti AG Feldkircherstraße 100 Schaan, 9494 - Liechtenstein T +423 234 2111 chemicals.hse@hilti.com
---	--

1.4. Emergency telephone number

Emergency number	Chem-Trec Tel.: 1 800 424 9300 (USA, PR, Virgin Islands, Canada) Tel.: 703 527 3887 (Other countries) +1 918 8723000 1-800-879-8000 toll free
------------------	---

SECTION 2: Hazard(s) identification

2.1. Classification of the substance or mixture

GHS-US classification

Not classified

2.2. GHS Label elements, including precautionary statements

GHS US labelling

No labelling applicable

2.3. Other hazards which do not result in classification

Other hazards which do not result in classification : A Safety Data Sheet is not required due to the classification of these products as "articles" according to Regulation (EC) No. 1907/2006 of 18 December 2006 (EU) / 29CFR 1910.1200 (U.S.A.). Consequently, these products are exempted from CLP / OSHA Labeling and SDS requirements.

2.4. Unknown acute toxicity (GHS US)

Not applicable

CFP-ES Endo-Shield

Safety Data Sheet

A safety data sheet is not required for this product. This Product Safety Information Sheet has been created on a voluntary basis

SECTION 3: Composition/information on ingredients

3.1. Substances

Not applicable

3.2. Mixtures

Name	Product identifier	%	GHS-US classification
Alkaline earth silicate	(CAS-No.) 436083-99-7	95 – 98	Not classified

Full text of hazard classes and H-statements : see section 16

SECTION 4: First-aid measures

4.1. Description of first aid measures

First-aid measures general	Never give anything by mouth to an unconscious person.
First-aid measures after inhalation	Remove person to fresh air and keep comfortable for breathing. Allow the victim to rest.
First-aid measures after skin contact	Wash skin with plenty of water. If skin irritation occurs: Get medical advice/attention.
First-aid measures after eye contact	Rinse cautiously with water for several minutes. Obtain medical attention if pain, blinking or redness persists.
First-aid measures after ingestion	Rinse mouth out with water. Drink plenty of water.

4.2. Most important symptoms and effects (acute and delayed)

Potential adverse human health effects and symptoms	Based on available data, the classification criteria are not met.
Symptoms/effects	Not expected to present a significant hazard under anticipated conditions of normal use.
Symptoms/effects after inhalation	Dust of the product, if present, may cause respiratory irritation after an excessive inhalation exposure.
Symptoms/effects after skin contact	Product dust may cause mechanical irritation to the skin and mucous membranes.
Symptoms/effects after eye contact	Dust from this product may cause eye irritation.

4.3. Immediate medical attention and special treatment, if necessary

No additional information available

SECTION 5: Fire-fighting measures

5.1. Suitable (and unsuitable) extinguishing media

Suitable extinguishing media	The product itself does not burn. Foam. Dry powder. Carbon dioxide. Water spray. Sand.
Unsuitable extinguishing media	Do not use a heavy water stream.

5.2. Specific hazards arising from the chemical

No additional information available

5.3. Special protective equipment and precautions for fire-fighters

Firefighting instructions	Prevent fire fighting water from entering the environment.
Protection during firefighting	Do not enter fire area without proper protective equipment, including respiratory protection.

SECTION 6: Accidental release measures

6.1. Personal precautions, protective equipment and emergency procedures

6.1.1. For non-emergency personnel

Protective equipment	Wear recommended personal protective equipment.
Emergency procedures	Evacuate unnecessary personnel.

CFP-ES Endo-Shield

Safety Data Sheet

A safety data sheet is not required for this product. This Product Safety Information Sheet has been created on a voluntary basis

Measures in case of dust release Wear suitable respiratory protection.

6.1.2. For emergency responders

No additional information available

6.2. Environmental precautions

No additional information available

6.3. Methods and material for containment and cleaning up

Methods for cleaning up Minimise generation of dust.

6.4. Reference to other sections

See Heading 8. Exposure controls and personal protection.

SECTION 7: Handling and storage

7.1. Precautions for safe handling

Precautions for safe handling Avoid dust formation. Do not breathe dust. Avoid contact with skin and eyes. Limit use of power tools unless in conjunction with local exhaust ventilation. Use hand tools whenever possible.

Hygiene measures Handle in accordance with good industrial hygiene and safety procedures.

7.2. Conditions for safe storage, including any incompatibilities

Storage conditions Keep container closed when not in use. Avoid creating or spreading dust. Store in a dry place.

SECTION 8: Exposure controls/personal protection

8.1. Control parameters

CFP-ES Endo-Shield
No additional information available
Alkaline earth silicate (436083-99-7)
No additional information available

8.2. Appropriate engineering controls

No additional information available

8.3. Individual protection measures/Personal protective equipment

Personal protective equipment:

Avoid all unnecessary exposure. Protective clothing. Gloves. Safety glasses.

Hand protection:

Wear protective gloves.

Type	Material	Permeation	Thickness (mm)	Penetration
Reusable gloves				

Eye protection:

Chemical goggles or safety glasses. EN 166

Skin and body protection:

Wear suitable protective clothing

Respiratory protection:

CFP-ES Endo-Shield

Safety Data Sheet

A safety data sheet is not required for this product. This Product Safety Information Sheet has been created on a voluntary basis

In case of dust formation use respirator with filter: Dust production: dust mask with filter type P2

Personal protective equipment symbol(s):



Other information:

Limit use of power tools unless in conjunction with local exhaust ventilation. Use hand tools whenever possible.

SECTION 9: Physical and chemical properties

9.1. Information on basic physical and chemical properties

Physical state	Solid
Colour	white
Odour	odourless
Odour threshold	No data available
pH	No data available
Melting point	1500 – 1550 °C
Freezing point	No data available
Boiling point	No data available
Flash point	No data available
Relative evaporation rate (butylacetate=1)	No data available
Flammability (solid, gas)	No data available
Vapour pressure	No data available
Relative vapour density at 20 °C	No data available
Relative density	2.6
Solubility	Insoluble.
Partition coefficient n-octanol/water (Log Pow)	No data available
Auto-ignition temperature	No data available
Decomposition temperature	No data available
Viscosity, kinematic	No data available
Viscosity, dynamic	No data available
Explosive limits	No data available
Explosive properties	No data available
Oxidising properties	No data available

9.2. Other information

No additional information available

SECTION 10: Stability and reactivity

10.1. Reactivity

The product is non-reactive under normal conditions of use, storage and transport.

10.2. Chemical stability

Stable under normal conditions.

10.3. Possibility of hazardous reactions

None under normal use.

10.4. Conditions to avoid

No additional information available

CFP-ES Endo-Shield

Safety Data Sheet

A safety data sheet is not required for this product. This Product Safety Information Sheet has been created on a voluntary basis

10.5. Incompatible materials

No additional information available

10.6. Hazardous decomposition products

No hazardous decomposition products known.

SECTION 11: Toxicological information

11.1. Information on toxicological effects

Acute toxicity (oral)	Not classified
Acute toxicity (dermal)	Not classified
Acute toxicity (inhalation)	Not classified
Skin corrosion/irritation	Not classified
Serious eye damage/irritation	Not classified
Respiratory or skin sensitisation	Not classified
Germ cell mutagenicity	Not classified
Carcinogenicity	Not classified
Reproductive toxicity	Not classified
STOT-single exposure	Not classified
STOT-repeated exposure	Not classified
Aspiration hazard	Not classified
Viscosity, kinematic	
Potential adverse human health effects and symptoms	Based on available data, the classification criteria are not met.
Symptoms/effects	Not expected to present a significant hazard under anticipated conditions of normal use.
Symptoms/effects after inhalation	Dust of the product, if present, may cause respiratory irritation after an excessive inhalation exposure.
Symptoms/effects after skin contact	Product dust may cause mechanical irritation to the skin and mucous membranes.
Symptoms/effects after eye contact	Dust from this product may cause eye irritation.

SECTION 12: Ecological information

12.1. Toxicity

No additional information available

12.2. Persistence and degradability

Alkaline earth silicate (436083-99-7)	
Persistence and degradability	Not established.

12.3. Bioaccumulative potential

Alkaline earth silicate (436083-99-7)	
Bioaccumulative potential	Not established.

12.4. Mobility in soil

No additional information available

12.5. Other adverse effects

No additional information available

CFP-ES Endo-Shield

Safety Data Sheet

A safety data sheet is not required for this product. This Product Safety Information Sheet has been created on a voluntary basis

SECTION 13: Disposal considerations

13.1. Disposal methods

Product/Packaging disposal recommendations Dispose in a safe manner in accordance with local/national regulations.

SECTION 14: Transport information

In accordance with ADR / IMDG / IATA / RID /

ADR	IMDG	IATA	RID
14.1. UN number			
Not applicable	Not applicable	Not applicable	Not applicable
14.2. UN proper shipping name			
Not applicable	Not applicable	Not applicable	Not applicable
14.3. Transport hazard class(es)			
Not applicable	Not applicable	Not applicable	Not applicable
14.4. Packing group			
Not applicable	Not applicable	Not applicable	Not applicable
14.5. Environmental hazards			
Not applicable	Not applicable	Not applicable	Not applicable
No supplementary information available			

14.6. Special precautions for user

Overland transport

Not applicable

Transport by sea

Not applicable

Air transport

Not applicable

Rail transport

Not applicable

14.7. Transport in bulk according to Annex II of Marpol and the IBC Code

Not applicable

SECTION 15: Regulatory information

15.1. US Federal regulations

All components of this product are listed, or excluded from listing, on the United States Environmental Protection Agency Toxic Substances Control Act (TSCA) inventory except for:

Alkaline earth silicate	CAS-No. 436083-99-7	95 – 98%
-------------------------	---------------------	----------

CFP-ES Endo-Shield

Safety Data Sheet

A safety data sheet is not required for this product. This Product Safety Information Sheet has been created on a voluntary basis

15.2. International regulations

CANADA

Alkaline earth silicate (436083-99-7)
--

Not listed on the Canadian DSL (Domestic Substances List)/NDSL (Non-Domestic Substances List)

EU-Regulations

No additional information available

National regulations

No additional information available

15.3. US State regulations

California Proposition 65 - This product does not contain any substances known to the state of California to cause cancer, developmental and/or reproductive harm

SECTION 16: Other information

A safety data sheet is not required for this product. This Product Safety Information Sheet has been created on a voluntary basis

SDS_US_Hilti

This information is based on our current knowledge and is intended to describe the product for the purposes of health, safety and environmental requirements only. It should not therefore be construed as guaranteeing any specific property of the product.

Flexible Firestop Sealant (CP 606)

Product description

- An acrylic based firestop sealant that provides movement capability in fire rated joints and seals through-penetrations applications

Product features

- Silicone free
- Halogen, asbestos and solvent free
- Paintable
- Tested up to 33% movement with 500 cycles in accordance to UL 2079 and ASTM 1966
- Smoke and fume resistant
- Easy clean up with water
- Single component systems available
- Meets LEED™ requirements for indoor environmental quality credit 4.1 Low Emitting Materials, Sealants and Adhesives and 4.2 Paints and Coatings

Areas of application

- Sealing construction/expansion joints
- Top-of-wall joints
- Metal pipes
- Cable bundles
- HVAC penetrations

For use with

- Various base materials such as masonry, concrete, gypsum, etc.
- Wall and floor assemblies rated up to 3 hours

Examples

- Where a gypsum wall assembly meets the underside of a metal or concrete deck
- Sealing expansion joints to impede the passage of fire, smoke and toxic fumes
- Sealing around HVAC penetrations through fire-rated assemblies

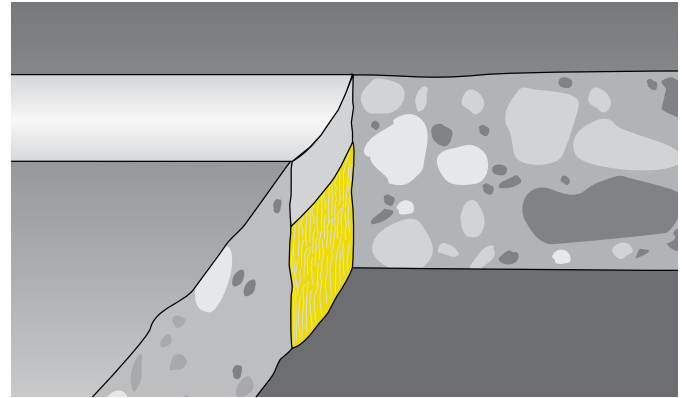

Technical Data*	CP 606
Chemical basis	Acrylic based firestop sealant
Color	Available in red, white and gray
Application temperature	40°F to 104°F (5°C to 40°C)
Skin-forming time	Approx. 15 min
Curing time	Approx. 3 mm / 3 days
Average volume shrinkage (ASTM C1241)	22.2%
Movement capability	Approx. 10%
Temperature resistance	-22°F to 176°F (-30°C to 80°C)
Surface burning characteristics (ASTM E 84-96)	Flame Spread: 10 Smoke Development: 0
Sound transmission classification (ASTM E 90-99)	56 (Relates to specific construction)
Tested in accordance with	<ul style="list-style-type: none"> • UL 2079 • ASTM E 814 • ASTM E 1966 • ASTM E 84 • UL 1479 • ASTM G21

*At 73°F (23°C) and 50% relative humidity

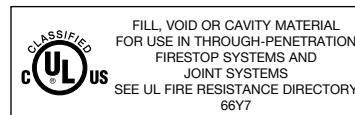

Installation instructions for CP 606

Notice

- Before handling, read Material Safety Data Sheet and product label for safe usage and health information.
- Instructions below are general guidelines — always refer to the applicable drawing in the UL Fire Resistance Directory or Hilti Firestop Systems Guide for complete installation information
- The use of backing material is recommended to control the sealant depth and help ensure assembly seal is complete

Opening

1. Clean the opening. Surfaces to which CP 606 will be applied should be cleaned of loose debris, dirt, oil, wax and grease. The surface should be moisture and frost free.

Application of firestop

2. Insert fill of mineral wool or backer (as required).
3. Apply firestop over backer.
4. Smooth firestop sealant with a trowel before the skin forms. Once cured, CP 606 can only be removed mechanically.
5. For maintenance reasons, a penetration seal can be

permanently marked with an identification plate and fastened in a visible position next to the seal.

Not for use

- On areas immersed in water

Storage

- Store only in the original packaging in a location protected from moisture at a temperature of 40°F to 77°F (5°C to 25°C)
- Observe expiration date on package

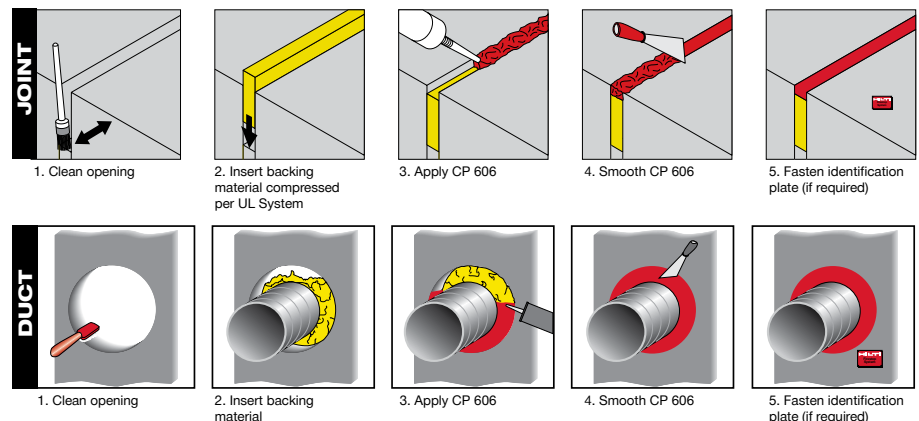

CERTIFICATE OF COMPLIANCE

Certificate Number 20160930-R13240
Report Reference R13240
Issue Date 2016-September-30

Issued to: Hilti Construction Chemicals, Div of Hilti Inc.
5400 S 122nd East Ave
Tulsa, OK 74146

This is to certify that representative samples of Fill, Void or Cavity Materials
Fill, Void or Cavity Materials Certified for Canada

CP 606 Sealant for use in Through-Penetration Firestop, Joint in wall and partition Systems as currently described in the UL Fire Resistance Directory and in the Products Certified for Canada Directory.

Have been investigated by UL in accordance with the Standard(s) indicated on this Certificate.

Standard(s) for Safety: ANSI/UL 1479, "Fire Tests of Through-Penetration Firestops,"
ANSI/UL 2079, "Tests for Fire Resistance of Building Joint Systems,"
CAN/ULC-S115, "Standard Method of Fire Tests of Firestop Systems."

Additional Information: See the UL Online Certifications Directory at www.ul.com/database for additional information

Only those products bearing the UL Certification Mark should be considered as being covered by UL's Certification and Follow-Up Service.

Look for the UL Certification Mark on the product.



Bruce Mahrenholz, Director North American Certification Program

UL LLC

Any information and documentation involving UL Mark services are provided on behalf of UL LLC (UL) or any authorized licensee of UL. For questions, please contact a local UL Customer Service Representative at <http://ul.com/aboutul/locations/>



Hilti Firestop Acrylic Sealant CFS-S ACR; CP 606

Safety Data Sheet

according to Federal Register / Vol. 77, No. 58 / Monday, March 26, 2012 / Rules and Regulations

Date of issue: 01/07/2016

Revision date: 01/07/2016

Supersedes: 01/07/2016

Version: 4.2

SECTION 1: Identification

1.1. Identification

Product form	Mixture
Name	Hilti Firestop Acrylic Sealant CFS-S ACR; CP 606
Product code	BU Chemicals
Chemical structure	

1.2. Relevant identified uses of the substance or mixture and uses advised against

No additional information available

1.3. Details of the supplier of the safety data sheet

Hilti, Inc.
 Legacy Tower, Suite 1000
 75024 Plano - USA
 T +1 9724035800
 1-800-879-8000 toll free - F +1 918 254 0522

Supplier
 Hilti, Inc.
 Legacy Tower, Suite 1000
 75024 Plano - USA
 T +1 9724035800
 1-800-879-8000 toll free - F +1 918 254 0522

Department issuing data specification sheet
 Hilti AG
 Feldkircherstraße 100
 9494 Schaan - Liechtenstein
 T +423 234 2111
chemicals.hse@hilti.com

1.4. Emergency telephone number

Emergency number	Chem-Trec Tel.: 1 800 424 9300 (USA, PR, Virgin Islands, Canada) Tel.: 703 527 3887 (Other countries) +1 918 8723000 1-800-879-8000 toll free
------------------	---

SECTION 2: Hazards identification

2.1. Classification of the substance or mixture

GHS-US classification

Not classified

2.2. Label elements

GHS-US labelling

No labelling applicable

2.3. Other hazards

No additional information available

2.4. Unknown acute toxicity (GHS US)

Not applicable

Hilti Firestop Acrylic Sealant CFS-S ACR; CP 606

Safety Data Sheet

according to Federal Register / Vol. 77, No. 58 / Monday, March 26, 2012 / Rules and Regulations

SECTION 3: Composition/information on ingredients

3.1. Substance

Not applicable

3.2. Mixture

Full text of H-statements: see section 16

SECTION 4: First aid measures

4.1. Description of first aid measures

First-aid measures after inhalation	Get medical advice/attention if you feel unwell.
First-aid measures after skin contact	Wash skin with plenty of water. If skin irritation occurs: Get medical advice/attention.
First-aid measures after eye contact	Rinse cautiously with water for several minutes. Remove contact lenses, if present and easy to do. Continue rinsing. If eye irritation persists: Get medical advice/attention.
First-aid measures after ingestion	Get medical advice/attention if you feel unwell.

4.2. Most important symptoms and effects, both acute and delayed

No additional information available

4.3. Indication of any immediate medical attention and special treatment needed

No additional information available

SECTION 5: Firefighting measures

5.1. Extinguishing media

Suitable extinguishing media	Water spray. Dry powder. Foam. Carbon dioxide.
------------------------------	--

5.2. Special hazards arising from the substance or mixture

Reactivity	The product is non-reactive under normal conditions of use, storage and transport.
------------	--

5.3. Advice for firefighters

Protection during firefighting	Self-contained breathing apparatus. Complete protective clothing.
--------------------------------	---

SECTION 6: Accidental release measures

6.1. Personal precautions, protective equipment and emergency procedures

6.1.1. For non-emergency personnel

No additional information available

6.1.2. For emergency responders

Protective equipment	For further information refer to section 8: "Exposure controls/personal protection".
----------------------	--

6.2. Environmental precautions

No additional information available

6.3. Methods and material for containment and cleaning up

Methods for cleaning up	Recover mechanically the product.
-------------------------	-----------------------------------

6.4. Reference to other sections

For further information refer to section 13.

Hilti Firestop Acrylic Sealant CFS-S ACR; CP 606

Safety Data Sheet

according to Federal Register / Vol. 77, No. 58 / Monday, March 26, 2012 / Rules and Regulations

SECTION 7: Handling and storage

7.1. Precautions for safe handling

Precautions for safe handling	Wear personal protective equipment.
Hygiene measures	Wash contaminated clothing before reuse. Do not eat, drink or smoke when using this product. Always wash hands after handling the product.

7.2. Conditions for safe storage, including any incompatibilities

Storage conditions	Keep cool. Store in a dry place.
Storage temperature	41 - 77 °F

SECTION 8: Exposure controls/personal protection

8.1. Control parameters

No additional information available

8.2. Exposure controls

Personal protective equipment Protective clothing. Safety glasses. Gloves.



Hand protection	Protective gloves. EN 374.
Eye protection	Safety glasses. EN 166. EN 170.
Skin and body protection	Wear suitable protective clothing.

SECTION 9: Physical and chemical properties

9.1. Information on basic physical and chemical properties

Physical state	Liquid
Appearance	Pasty.
Colour	red white Grey
Odour	characteristic
Odour threshold	Not determined
pH	≈ 9 Not applicable
Melting point	Not applicable
Freezing point	No data available
Boiling point	No data available
Flash point	Not applicable
Relative evaporation rate (butylacetate=1)	No data available
Flammability (solid, gas)	No data available
Explosive limits	No data available
Explosive properties	No data available
Oxidising properties	No data available
Vapour pressure	No data available
Relative density	No data available
Relative vapour density at 20 °C	No data available
Density	1.6 g/cm ³
Molecular mass	Not determined
Solubility	No data available

Hilti Firestop Acrylic Sealant CFS-S ACR; CP 606

Safety Data Sheet

according to Federal Register / Vol. 77, No. 58 / Monday, March 26, 2012 / Rules and Regulations

Log Pow	No data available
Auto-ignition temperature	No data available
Decomposition temperature	No data available
Viscosity	No data available
Viscosity, kinematic	No data available
Viscosity, dynamic	No data available

9.2. Other information

No additional information available

SECTION 10: Stability and reactivity

10.1. Reactivity

The product is non-reactive under normal conditions of use, storage and transport.

10.2. Chemical stability

Stable under normal conditions.

10.3. Possibility of hazardous reactions

No dangerous reactions known under normal conditions of use.

10.4. Conditions to avoid

None under recommended storage and handling conditions (see section 7).

10.5. Incompatible materials

No additional information available

10.6. Hazardous decomposition products

Under normal conditions of storage and use, hazardous decomposition products should not be produced.

SECTION 11: Toxicological information

11.1. Information on toxicological effects

Acute toxicity	Not classified
Skin corrosion/irritation	Not classified pH: ≈ 9 Not applicable
Serious eye damage/irritation	Not classified pH: ≈ 9 Not applicable
Respiratory or skin sensitisation	Not classified
Germ cell mutagenicity	Not classified
Carcinogenicity	Not classified
Reproductive toxicity	Not classified
Specific target organ toxicity (single exposure)	Not classified
Specific target organ toxicity (repeated exposure)	Not classified
Aspiration hazard	Not classified

Hilti Firestop Acrylic Sealant CFS-S ACR; CP 606

Safety Data Sheet

according to Federal Register / Vol. 77, No. 58 / Monday, March 26, 2012 / Rules and Regulations

SECTION 12: Ecological information

12.1. Toxicity

Ecology - general

The product is not considered harmful to aquatic organisms or to cause long-term adverse effects in the environment.

12.2. Persistence and degradability

No additional information available

12.3. Bioaccumulative potential

No additional information available

12.4. Mobility in soil

No additional information available

12.5. Other adverse effects

Effect on the global warming

No known ecological damage caused by this product.

SECTION 13: Disposal considerations

13.1. Waste treatment methods

Waste treatment methods

Dispose of contents/container in accordance with licensed collector's sorting instructions.

Waste disposal recommendations

Dispose in a safe manner in accordance with local/national regulations.

SECTION 14: Transport information

In accordance with ADR / RID / IMDG / IATA / ADN

14.1. UN number

Not regulated for transport

14.2. UN proper shipping name

Proper Shipping Name (ADR)	Not applicable
Proper Shipping Name (IMDG)	Not applicable
Proper Shipping Name (IATA)	Not applicable
Proper Shipping Name (ADN)	Not applicable
Proper Shipping Name (RID)	Not applicable

14.3. Transport hazard class(es)

ADR

Transport hazard class(es) (ADR) Not applicable

IMDG

Transport hazard class(es) (IMDG) Not applicable

IATA

Transport hazard class(es) (IATA) Not applicable

ADN

Transport hazard class(es) (ADN) Not applicable

RID

Hilti Firestop Acrylic Sealant CFS-S ACR; CP 606

Safety Data Sheet

according to Federal Register / Vol. 77, No. 58 / Monday, March 26, 2012 / Rules and Regulations

Transport hazard class(es) (RID) Not applicable

14.4. Packing group

Packing group (ADR)	Not applicable
Packing group (IMDG)	Not applicable
Packing group (IATA)	Not applicable
Packing group (ADN)	Not applicable
Packing group (RID)	Not applicable

14.5. Environmental hazards

Dangerous for the environment	No
Marine pollutant	No
Other information	No supplementary information available

14.6. Special precautions for user

- Overland transport

- Transport by sea

No data available

- Air transport

No data available

- Inland waterway transport

Carriage prohibited (ADN)	No
Not subject to ADN	No

- Rail transport

Carriage prohibited (RID)	No
---------------------------	----

14.7. Transport in bulk according to Annex II of MARPOL 73/78 and the IBC Code

SECTION 15: Regulatory information

15.1. US Federal regulations

This product or mixture does not contain a toxic chemical or chemicals in excess of the applicable de minimis concentration as specified in 40 CFR §372.38(a) subject to the reporting requirements of section 313 of Title III of the Superfund Amendments and Reauthorization Act of 1986 and 40 CFR Part 372.

15.2. International regulations

CANADA

Hilti Firestop Acrylic Sealant CFS-S ACR; CP 606	
WHMIS Classification	Uncontrolled product according to WHMIS classification criteria

EU-Regulations

No additional information available

Classification according to Regulation (EC) No. 1272/2008 [CLP]

Not classified

National regulations

No additional information available

Hilti Firestop Acrylic Sealant CFS-S ACR; CP 606

Safety Data Sheet

according to Federal Register / Vol. 77, No. 58 / Monday, March 26, 2012 / Rules and Regulations

15.3. US State regulations

California Proposition 65 - This product does not contain any substances known to the state of California to cause cancer, developmental and/or reproductive harm

SECTION 16: Other information

Revision date 01/07/2016

HMIS III Rating

Health	0 Minimal Hazard - No significant risk to health
Flammability	0 Minimal Hazard - Materials that will not burn
Physical	0 Minimal Hazard - Materials that are normally stable, even under fire conditions, and will NOT react with water, polymerize, decompose, condense, or self-react. Non-Explosives.
Personal Protection	B B - Safety glasses, Gloves

SDS_US_Hilti

This information is based on our current knowledge and is intended to describe the product for the purposes of health, safety and environmental requirements only. It should not therefore be construed as guaranteeing any specific property of the product



February 26, 2010

To Whom It May Concern:

Re: Hilti CP 606 Flexible Firestop – LEEDs Info.

The Hilti CP 606 Flexible Firestop Sealant is manufactured in Germany.

The CP 606 pail is made of polyethylene and can be completely recycled. There is no post-consumer or post-industrial content in CP 606 and it cannot be recycled. The CP 606 does not contain any Rapidly Renewable Materials. The VOC content for CP 606 is 71.0 grams/liter.

CP 606 is not regulated as a hazardous waste by the Federal EPA Standards. The regulations for the disposal of non-regulated industrial waste can vary from state to state and even city to city. For this reason, you should consult your local and state regulatory agencies for direction on disposal.

Please feel free to contact me at (918) 872-3704 if you have questions.

Sincerely,

A handwritten signature in black ink, reading "Jerry Metcalf". The signature is written in a cursive style with a large, prominent "J" and "M".

Jerry Metcalf MPH, CHMM
Safety/Environmental Manager
Hilti Inc.
918 872 3704
jerry.metcalf@hilti.com

Rev. Date: 2/26/10

Hilti, Inc.
5400 South 122nd East Avenue
Tulsa, OK 74146

1-800-879-8000
www.hilti.com

FIRESTOP PUTTY STICK CP 618

Product description

- Easily moldable and reusable firestop putty designed to help create a fire and smoke barrier around cables and metal pipes

Applications for use

- Non-hardening, firestop putty for single or bundled cables and non-combustible pipe penetrations
- Concrete-, masonry-, and gypsum-wall assemblies
- Wall and floor assemblies rated up to 3 hours
- Where telecommunication and data lines penetrate gypsum-wall assemblies
- Where steel conduit and EMT penetrate concrete- and block-wall assemblies
- Where blank openings exist in concrete- and block-wall assemblies

Advantages

- Quicker, simpler to install and reusable — does not harden over time
- Approval for virtually any transit type — telecom, low- and medium-voltage cables, conduits, metal pipes, and blank openings
- Adheres to concrete-, masonry-, and gypsum-wall assemblies
- Mold and mildew resistant
- Acoustically tested according to ASTM E90
- Asbestos, formaldehyde and LABS free
- Red list compliant
- Living Building Challenge (LBC) compliant

Installation instructions

- See Hilti literature or third-party listings for complete application and installation details



Technical Data

Chemical basis	Moldable putty
Color	Red
Recommended application temperature	32° F to 104° F (0° C to 40° C)
Storage and transportation temperature range	23° F to 104°F (-5° C to 40° C)
Temperature resistance range	-40° F to 104°F (-40° C to 40° C)
Mold and mildew performance	Class 0 (ASTM G21-96)
Tested in accordance with	UL 1479, CAN / ULC-S115, ASTM E814
Surface burning characteristics (ASTM E84)	Flame Spread 15 Smoke Development 10
Product activation	284° F (140° C)
LEED VOC	5 g/L
Can be painted	No
Acoustics performance	49 (relates to specific construction) ASTM E90
Shelf life	Not relevant
Volume per unit	18 in ³

Order designation	Sales pack quantity	Item number
CP 618 Putty stick (single)	1	3474775
CP 618 Putty stick	12	314721

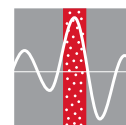

CERTIFICATE OF COMPLIANCE

Certificate Number R13240
Report Reference R13240-20191126
Issue Date 2020-MARCH-11

Issued to: HILTI CONSTRUCTION CHEMICALS, DIV OF HILTI INC
7250 Dallas Pky, Legacy Tower Suite 1000
Plano TX 75024

**This certificate confirms that
representative samples of**

FILL, VOID OR CAVITY MATERIALS
Putty Stick identified as Hilti CP 618 for use in Through-
Penetration Firestop Systems.
Hilti CFS-D 1" Firestop Putty Discs to be used in Through-
Penetration Firestop Systems.

Have been investigated by UL in accordance with the
Standard(s) indicated on this Certificate.

Standard(s) for Safety: ANSI/UL 1479, Fire Tests of Penetration Firestops.
CAN/ULC-S115, Method of Fire Tests of Firestops Systems

Additional Information: See the UL Online Certifications Directory at
<https://iq.ulprospector.com> for additional information.

This *Certificate of Compliance* does not provide authorization to apply the UL Mark. Only the UL Follow-Up Services Procedure provides authorization to apply the UL Mark.

Only those products bearing the UL Mark should be considered as being UL Certified and covered under UL's Follow-Up Services.

Look for the UL Certification Mark on the product.

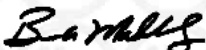

Bruce Mahrenholz, Director North American Certification Program

UL LLC

Any information and documentation involving UL Mark services are provided on behalf of UL LLC (UL) or any authorized licensee of UL. For questions, please contact a local UL Customer Service Representative at <http://ul.com/aboutul/locations/>



CFS-P BA, CP 617, CP 618, CP 619, CFS-D 1", CFS-D 25

Safety Data Sheet

according to Federal Register / Vol. 77, No. 58 / Monday, March 26, 2012 / Rules and Regulations

Date of issue: 10/18/2019

Revision date: 10/18/2019

Supersedes: 09/22/2016

Version: 2.7

SECTION 1: Identification

1.1. Identification

Product form	Mixture
Trade name	CFS-P BA, CP 617, CP 618, CP 619, CFS-D 1", CFS-D 25
Product code	BU Fire Protection

1.2. Relevant identified uses of the substance or mixture and uses advised against

Use of the substance/mixture	Firestop putty pad
------------------------------	--------------------

1.3. Details of the supplier of the safety data sheet

Hilti, Inc.
Legacy Tower, Suite 1000
7250 Dallas Parkway
TX 75024 Plano - USA
T +1 9724035800
1-800-879-8000 toll free - F +1 918 254 0522

Supplier

Hilti, Inc.
Legacy Tower, Suite 1000
7250 Dallas Parkway
TX 75024 Plano - USA
T +1 9724035800
1-800-879-8000 toll free - F +1 918 254 0522

Department issuing data specification sheet

Hilti AG
Feldkircherstraße 100
9494 Schaan - Liechtenstein
T +423 234 2111
chemicals.hse@hilti.com

1.4. Emergency telephone number

Emergency number	Chem-Trec Tel.: 1 800 424 9300 (USA, PR, Virgin Islands, Canada) Tel.: 703 527 3887 (Other countries) +1 918 8723000 1-800-879-8000 toll free
------------------	---

SECTION 2: Hazards identification

2.1. Classification of the substance or mixture

GHS-US classification

Not classified

2.2. Label elements

GHS US labelling

No labelling applicable

2.3. Other hazards

No additional information available

2.4. Unknown acute toxicity (GHS US)

Not applicable

CFS-P BA, CP 617, CP 618, CP 619, CFS-D 1", CFS-D 25

Safety Data Sheet

according to Federal Register / Vol. 77, No. 58 / Monday, March 26, 2012 / Rules and Regulations

SECTION 3: Composition/information on ingredients

3.1. Substances

Not applicable

3.2. Mixtures

Full text of H-statements: see section 16

SECTION 4: First aid measures

4.1. Description of first aid measures

First-aid measures general	Never give anything by mouth to an unconscious person. If you feel unwell, seek medical advice (show the label where possible).
First-aid measures after inhalation	Get medical advice/attention if you feel unwell. Allow affected person to breathe fresh air. Allow the victim to rest.
First-aid measures after skin contact	Wash skin with plenty of water. If skin irritation occurs: Get medical advice/attention. Remove affected clothing and wash all exposed skin area with mild soap and water, followed by warm water rinse.
First-aid measures after eye contact	Rinse cautiously with water for several minutes. Remove contact lenses, if present and easy to do. Continue rinsing. If eye irritation persists: Get medical advice/attention. Rinse immediately with plenty of water. Obtain medical attention if pain, blinking or redness persists.
First-aid measures after ingestion	Get medical advice/attention if you feel unwell. Rinse mouth. Do NOT induce vomiting. Obtain emergency medical attention.

4.2. Most important symptoms and effects (acute and delayed)

Potential adverse human health effects and symptoms	Based on available data, the classification criteria are not met.
Symptoms/effects	Not expected to present a significant hazard under anticipated conditions of normal use.

4.3. Immediate medical attention and special treatment, if necessary

SECTION 5: Firefighting measures

5.1. Extinguishing media

Suitable extinguishing media	Water spray. Dry powder. Foam. Carbon dioxide. Sand.
Unsuitable extinguishing media	Do not use a heavy water stream.

5.2. Special hazards arising from the substance or mixture

Reactivity	The product is non-reactive under normal conditions of use, storage and transport.
------------	--

5.3. Advice for firefighters

Firefighting instructions	Use water spray or fog for cooling exposed containers. Exercise caution when fighting any chemical fire. Prevent fire fighting water from entering the environment.
Protection during firefighting	Self-contained breathing apparatus. Complete protective clothing. Do not enter fire area without proper protective equipment, including respiratory protection.

CFS-P BA, CP 617, CP 618, CP 619, CFS-D 1", CFS-D 25

Safety Data Sheet

according to Federal Register / Vol. 77, No. 58 / Monday, March 26, 2012 / Rules and Regulations

SECTION 6: Accidental release measures

6.1. Personal precautions, protective equipment and emergency procedures

6.1.1. For non-emergency personnel

Emergency procedures Evacuate unnecessary personnel.

6.1.2. For emergency responders

Protective equipment For further information refer to section 8: "Exposure controls/personal protection". Equip cleanup crew with proper protection.

Emergency procedures Ventilate area.

6.2. Environmental precautions

Prevent entry to sewers and public waters. Notify authorities if liquid enters sewers or public waters.

6.3. Methods and material for containment and cleaning up

Methods for cleaning up Mechanically recover the product. On land, sweep or shovel into suitable containers. Minimise generation of dust. Store away from other materials.

6.4. Reference to other sections

For further information refer to section 13. See Heading 8. Exposure controls and personal protection.

SECTION 7: Handling and storage

7.1. Precautions for safe handling

Precautions for safe handling Wear personal protective equipment. Wash hands and other exposed areas with mild soap and water before eating, drinking or smoking and when leaving work. Provide good ventilation in process area to prevent formation of vapour.

Hygiene measures Wash contaminated clothing before reuse. Do not eat, drink or smoke when using this product. Always wash hands after handling the product.

7.2. Conditions for safe storage, including any incompatibilities

Storage conditions Keep cool. Store in a dry place. Keep only in the original container in a cool, well ventilated place away from : Keep container closed when not in use.

Incompatible products Strong bases. Strong acids.

Incompatible materials Sources of ignition. Direct sunlight.

Storage temperature 23 - 104 °F

SECTION 8: Exposure controls/personal protection

8.1. Control parameters

Additional information The product has a pasty consistency. Exposure limit values for respirable dusts are not relevant for this product.

8.2. Exposure controls

Personal protective equipment Protective clothing. Safety glasses. Gloves. Avoid all unnecessary exposure.



Hand protection Protective gloves. EN 374. Wear protective gloves.

CFS-P BA, CP 617, CP 618, CP 619, CFS-D 1", CFS-D 25

Safety Data Sheet

according to Federal Register / Vol. 77, No. 58 / Monday, March 26, 2012 / Rules and Regulations

Eye protection	Chemical goggles or safety glasses.
Skin and body protection	Wear suitable protective clothing.
Respiratory protection	Wear appropriate mask.
Other information	Do not eat, drink or smoke during use.

SECTION 9: Physical and chemical properties

9.1. Information on basic physical and chemical properties

Physical state	Solid
Appearance	Pasty.
Colour	red
Odour	characteristic
Odour threshold	Not determined
pH	Not relevant
Melting point	Not applicable
Freezing point	No data available
Boiling point	No data available
Flash point	Not applicable
Relative evaporation rate (butylacetate=1)	No data available
Flammability (solid, gas)	No data available
Explosive limits	No data available
Explosive properties	No data available
Oxidising properties	No data available
Vapour pressure	No data available
Relative density	No data available
Relative vapour density at 20 °C	No data available
Density	1.6 g/cm ³
Molecular mass	Not determined
Solubility	No data available
Log Pow	No data available
Auto-ignition temperature	No data available
Decomposition temperature	No data available
Viscosity	No data available
Viscosity, kinematic	No data available
Viscosity, dynamic	No data available

9.2. Other information

No additional information available

SECTION 10: Stability and reactivity

10.1. Reactivity

The product is non-reactive under normal conditions of use, storage and transport.

10.2. Chemical stability

Stable under normal conditions. Not established.

CFS-P BA, CP 617, CP 618, CP 619, CFS-D 1", CFS-D 25

Safety Data Sheet

according to Federal Register / Vol. 77, No. 58 / Monday, March 26, 2012 / Rules and Regulations

10.3. Possibility of hazardous reactions

No dangerous reactions known under normal conditions of use. Not established.

10.4. Conditions to avoid

None under recommended storage and handling conditions (see section 7). Direct sunlight. Extremely high or low temperatures.

10.5. Incompatible materials

Strong acids. Strong bases.

10.6. Hazardous decomposition products

Under normal conditions of storage and use, hazardous decomposition products should not be produced. fume. Carbon monoxide. Carbon dioxide.

SECTION 11: Toxicological information

11.1. Information on toxicological effects

Acute toxicity	Not classified
Skin corrosion/irritation	Not classified pH: Not relevant
Serious eye damage/irritation	Not classified pH: Not relevant
Respiratory or skin sensitisation	Not classified
Germ cell mutagenicity	Not classified
Carcinogenicity	Based on available data, the classification criteria are not met
Reproductive toxicity	Not classified
STOT-single exposure	Based on available data, the classification criteria are not met
STOT-repeated exposure	Not classified
Aspiration hazard	Not classified
Potential adverse human health effects and symptoms	Based on available data, the classification criteria are not met.

SECTION 12: Ecological information

12.1. Toxicity

Ecology - general The product is not considered harmful to aquatic organisms nor to cause long-term adverse effects in the environment.

12.2. Persistence and degradability

CFS-P BA, CP 617, CP 618, CP 619, CFS-D 1", CFS-D 25	
Persistence and degradability	Not established.

12.3. Bioaccumulative potential

CFS-P BA, CP 617, CP 618, CP 619, CFS-D 1", CFS-D 25	
Bioaccumulative potential	Not established.

CFS-P BA, CP 617, CP 618, CP 619, CFS-D 1", CFS-D 25

Safety Data Sheet

according to Federal Register / Vol. 77, No. 58 / Monday, March 26, 2012 / Rules and Regulations

12.4. Mobility in soil

No additional information available

12.5. Other adverse effects

Other information

Avoid release to the environment.

SECTION 13: Disposal considerations

13.1. Waste treatment methods

Waste treatment methods

Dispose in a safe manner in accordance with local/national regulations.

Product/Packaging disposal recommendations

Dispose in a safe manner in accordance with local/national regulations.

Ecology - waste materials

Avoid release to the environment.

SECTION 14: Transport information

In accordance with ADR / RID / IMDG / IATA / ADN

ADR	IMDG	IATA	RID
14.1. UN number			
Not applicable	Not applicable	Not applicable	Not applicable
14.2. UN proper shipping name			
Not applicable	Not applicable	Not applicable	Not applicable
14.3. Transport hazard class(es)			
Not applicable	Not applicable	Not applicable	Not applicable
14.4. Packing group			
Not applicable	Not applicable	Not applicable	Not applicable
14.5. Environmental hazards			
Dangerous for the environment : No	Dangerous for the environment : No Marine pollutant : No	Dangerous for the environment : No	Dangerous for the environment : No
No supplementary information available			

14.6. Special precautions for user

- Overland transport

- Transport by sea

No data available

- Air transport

No data available

- Rail transport

Carriage prohibited (RID)

No

CFS-P BA, CP 617, CP 618, CP 619, CFS-D 1", CFS-D 25

Safety Data Sheet

according to Federal Register / Vol. 77, No. 58 / Monday, March 26, 2012 / Rules and Regulations

14.7. Transport in bulk according to Annex II of MARPOL and the IBC Code

SECTION 15: Regulatory information

15.1. US Federal regulations

All components of this product are listed, or excluded from listing, on the United States Environmental Protection Agency Toxic Substances Control Act (TSCA) inventory

15.2. International regulations

CANADA

No additional information available

EU-Regulations

No additional information available

National regulations

No additional information available

15.3. US State regulations

California Proposition 65 - This product does not contain any substances known to the state of California to cause cancer, developmental and/or reproductive harm

SECTION 16: Other information

Revision date	10/18/2019
Data sources	REGULATION (EC) No 1272/2008 OF THE EUROPEAN PARLIAMENT AND OF THE COUNCIL of 16 December 2008 on classification, labelling and packaging of substances and mixtures, amending and repealing Directives 67/548/EEC and 1999/45/EC, and amending Regulation (EC) No 1907/2006.
Other information	None.
NFPA health hazard	0 - Materials that, under emergency conditions, would offer no hazard beyond that of ordinary combustible materials.
NFPA fire hazard	0 - Materials that will not burn under typical fire conditions, including intrinsically noncombustible materials such as concrete, stone, and sand.
NFPA reactivity	0 - Material that in themselves are normally stable, even under fire conditions.

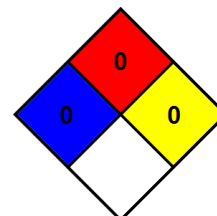



CFS-P BA, CP 617, CP 618, CP 619, CFS-D 1", CFS-D 25

Safety Data Sheet

according to Federal Register / Vol. 77, No. 58 / Monday, March 26, 2012 / Rules and Regulations

Hazard Rating

Health 0 Minimal Hazard - No significant risk to health
Flammability 0 Minimal Hazard - Materials that will not burn
Physical 0 Minimal Hazard - Materials that are normally stable, even under fire conditions, and will NOT react with water, polymerize, decompose, condense, or self-react. Non-Explosives.
Personal protection B
B - Safety glasses, Gloves

Indication of changes:

Section	Changed item	Change	Comments
			general update

SDS_US_Hilti

This information is based on our current knowledge and is intended to describe the product for the purposes of health, safety and environmental requirements only. It should not therefore be construed as guaranteeing any specific property of the product.

eco-INSTITUT, Schanzenstr. 6-20, D-51063 Köln

Hilti Entwicklungsgesellschaft mbH
Mr. Sebastian Simon
Hiltistraße 6
D-86916 Kaufering

Dear Mr. Simon,

based on the evaluation of Test Report No. 54789-001 dated 2019-11-26, the testing results of the product

CP 618 – Firestop Putty Stick

manufactured by

Hilti Entwicklungsgesellschaft mbH

comply with the requirements of

- VOC product emissions acc. to California Department of Public Health (CDPH) Standard Method v1.2-2017 (California Specification 01350 (01/2017))

These criteria meet the requirements for low-emitting **Adhesives and Sealants** in credit EQc2 of the LEEDv4 Rating System and the LEEDv4.1 Rating System.

Cologne, 2019-11-26



Marc-Anton Dobaj, M.Sc. Crystalline Materials
(Project manager)

High-performance intumescent firestop sealant FS-ONE MAX

Applications

- For effectively sealing most common through penetrations in a variety of base materials
- For use on concrete, masonry and drywall
- Mixed and multiple penetrations
- Metal pipe penetrations: copper, steel and EMT
- Insulated metal pipe penetrations: steel and copper
- Plastic pipe penetrations: closed or vented

Advantages

- US-produced: "Buy American" compliant
- One product for a variety of common through penetrations
- Cost-effective, easy-to-use solution
- Water-based and paintable
- Industry-leading VOC results
- Ethylene glycol-free

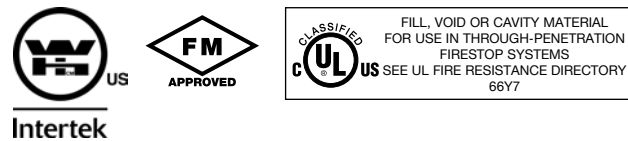
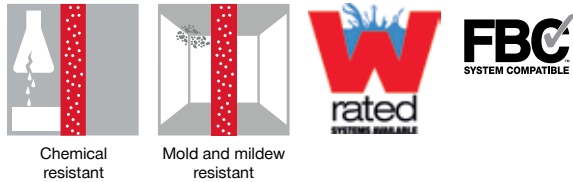
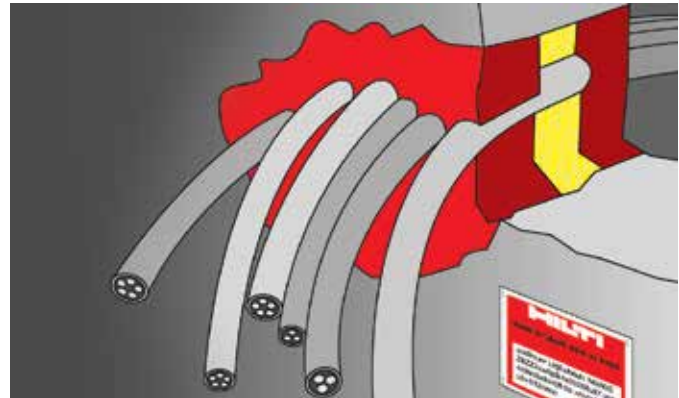

Technical data	
Chemical basis	Water-based acrylic dispersion
Approx. Density	84.3 lb/ft ³
Color	Red
Application temperature range	41 - 104 °F
Approx. cure time ¹⁾	4 mm/3 days
Temperature resistance range	-4 to 212 °F
Mold and mildew performance	Class 0 (ASTM G21-96)
Mold and mildew resistance	Yes
Surface burning characteristics UL 723 (ASTM E84)	Flame spread: 0 Smoke development: 10
Tested in accordance with	UL 1479, ASTM E814, ASTM E84, CAN/ ULC-S115, ASTM G21, ASTM E90
California State fire marshal approval	CSFM Listing 4485-1200:0108 for FS-ONE MAX Intumescent Firestop Sealant
Expansion ratio (unrestricted, up to)	1:5

¹⁾ at 75°F/24°C, 50% relative humidity



Order Designation	Package Content	Item number
FS-ONE MAX 20oz foil (3 case + disp)	1x Foil pack dispenser manual CS 270-P1, 75x Firestop sealant FS-ONE MAX 20 oz foil	3530252
FS-ONE MAX 10oz tube (1 case)	12x Firestop sealant FS-ONE MAX 10 oz cartridge	3530249
FS-ONE MAX 5 gallon (18 pails)	18x Firestop sealant FS-ONE MAX 5 gallon pail	3530263
FS-ONE MAX 20oz foil (1 case)	25x Firestop sealant FS-ONE MAX 20 oz foil	3530250
FS-ONE MAX 20oz foil (3 cases)	75x Firestop sealant FS-ONE MAX 20 oz foil	3530251
FS-ONE MAX 20oz Foil-Pallet	600x FSONE-MAX 20 oz foil, 290x Bulk Shipping Condition	3534713
FS-ONE MAX 10 oz cartridge		2101531
FS-ONE MAX 5 gallon pail		2101533

CERTIFICATE OF COMPLIANCE

Certificate Number 20150108-R13240
Report Reference R13240
Issue Date 2015-January-08

Issued to: Hilti Construction Chemicals, Div of Hilti Inc.
5400 S 122nd East Ave
Tulsa, OK 74146

**This is to certify that
representative samples of**

Fill, Void or Cavity Materials
Fill, Void or Cavity Materials Certified for Canada
FS-ONE MAX Intumescent Sealant for use in Through-
Penetration Firestop and Joint Systems in the UL Fire
Resistance Directory and in the Products Certified for
Canada Directory.

Have been investigated by UL in accordance with the
Standard(s) indicated on this Certificate.

Standard(s) for Safety: ANSI/UL 1479, "Fire Tests of Through-Penetration
Firestops," – Edition 4
ANSI/UL 2079, "Tests for Fire Resistance of Building Joint
Systems," – Edition 4 – Revision Date 2014/12/17
CAN/ULC-S115, "Standard Method of Fire Tests of Firestop
Systems." – Edition 4 – Issue Date 2011/06/01

Additional Information: See the UL Online Certifications Directory at
www.ul.com/database for additional information

Only those products bearing the UL Classification Mark should be considered as being covered by
UL's Classification and Follow-Up Service.

The UL Classification Mark includes: UL in a circle: with the word "CLASSIFIED"  (as shown); a control
number (may be alphanumeric) assigned by UL; a statement to indicate the extent of UL's evaluation of
the product; and the product category name (product identity) as indicated in the appropriate UL
Directory.

Look for the UL Classification Mark on the product.

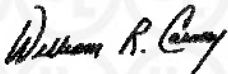

William R. Carney, Director, North American Certification Programs

UL LLC

Any information and documentation involving UL Mark services are provided on behalf of UL LLC (UL) or any authorized licensee of UL. For questions, please
contact a local UL Customer Service Representative at www.ul.com/contactus



FS-ONE MAX; CFS-FIL

Safety Data Sheet

according to Federal Register / Vol. 77, No. 58 / Monday, March 26, 2012 / Rules and Regulations

Date of issue: 07/04/2017

Revision date: 07/04/2017

Supersedes: 12/17/2015

Version: 1.3

SECTION 1: Identification

1.1. Identification

Product form	Mixture
Name	FS-ONE MAX; CFS-FIL
Product code	BU Fire Protection
Chemical structure	



1.2. Relevant identified uses of the substance or mixture and uses advised against

No additional information available

1.3. Details of the supplier of the safety data sheet

Hilti, Inc.
 Legacy Tower, Suite 1000
 75024 Plano - USA
 T +1 9724035800
 1-800-879-8000 toll free - F +1 918 254 0522

Supplier

Hilti, Inc.
 Legacy Tower, Suite 1000
 75024 Plano - USA
 T +1 9724035800
 1-800-879-8000 toll free - F +1 918 254 0522

Department issuing data specification sheet

Hilti AG
 Feldkircherstraße 100
 9494 Schaan - Liechtenstein
 T +423 234 2111
chemicals.hse@hilti.com

1.4. Emergency telephone number

Emergency number	Chem-Trec Tel.: 1 800 424 9300 (USA, PR, Virgin Islands, Canada) Tel.: 703 527 3887 (Other countries) +1 918 8723000 1-800-879-8000 toll free
------------------	---

SECTION 2: Hazards identification

2.1. Classification of the substance or mixture

GHS-US classification

Not classified

2.2. Label elements

GHS-US labelling

No labelling applicable

2.3. Other hazards

No additional information available

2.4. Unknown acute toxicity (GHS US)

Not applicable

FS-ONE MAX; CFS-FIL

Safety Data Sheet

according to Federal Register / Vol. 77, No. 58 / Monday, March 26, 2012 / Rules and Regulations

SECTION 3: Composition/information on ingredients

3.1. Substance

Not applicable

3.2. Mixture

Name	Product identifier	%	GHS-US classification
Quartz	(CAS No) 14808-60-7	2.5 - 5	Carc. 1A, H350

Full text of H-statements: see section 16

SECTION 4: First aid measures

4.1. Description of first aid measures

First-aid measures after inhalation	Get medical advice/attention if you feel unwell.
First-aid measures after skin contact	Wash skin with plenty of water. If skin irritation occurs: Get medical advice/attention.
First-aid measures after eye contact	Rinse cautiously with water for several minutes. Remove contact lenses, if present and easy to do. Continue rinsing. If eye irritation persists: Get medical advice/attention.
First-aid measures after ingestion	Get medical advice/attention if you feel unwell.

4.2. Most important symptoms and effects, both acute and delayed

No additional information available

4.3. Indication of any immediate medical attention and special treatment needed

No additional information available

SECTION 5: Firefighting measures

5.1. Extinguishing media

Suitable extinguishing media Water spray. Dry powder. Foam. Carbon dioxide.

5.2. Special hazards arising from the substance or mixture

Reactivity The product is non-reactive under normal conditions of use, storage and transport.

5.3. Advice for firefighters

Protection during firefighting Self-contained breathing apparatus. Complete protective clothing.

SECTION 6: Accidental release measures

6.1. Personal precautions, protective equipment and emergency procedures

6.1.1. For non-emergency personnel

No additional information available

6.1.2. For emergency responders

Protective equipment For further information refer to section 8: "Exposure controls/personal protection".

6.2. Environmental precautions

No additional information available

6.3. Methods and material for containment and cleaning up

Methods for cleaning up Mechanically recover the product.

6.4. Reference to other sections

For further information refer to section 13.

FS-ONE MAX; CFS-FIL

Safety Data Sheet

according to Federal Register / Vol. 77, No. 58 / Monday, March 26, 2012 / Rules and Regulations

SECTION 7: Handling and storage

7.1. Precautions for safe handling

Precautions for safe handling	Wear personal protective equipment.
Hygiene measures	Wash contaminated clothing before reuse. Do not eat, drink or smoke when using this product. Always wash hands after handling the product.

7.2. Conditions for safe storage, including any incompatibilities

Storage conditions	Keep cool. Store in a dry place.
Storage temperature	41 - 77 °F

SECTION 8: Exposure controls/personal protection

8.1. Control parameters

Quartz (14808-60-7)		
OSHA	Remark (OSHA)	(3) See Table Z-3.

Additional information The product has a pasty consistency. Exposure limit values for respirable dusts are not relevant for this product

8.2. Exposure controls

Personal protective equipment Protective clothing. Safety glasses. Gloves.



Hand protection	Protective gloves. EN 374.
Eye protection	Chemical goggles or safety glasses.
Skin and body protection	Wear suitable protective clothing.

SECTION 9: Physical and chemical properties

9.1. Information on basic physical and chemical properties

Physical state	Liquid
Appearance	Pasty.
Colour	red
Odour	characteristic
Odour threshold	Not determined
pH	≈ 7.85
Melting point	Not applicable
Freezing point	No data available
Boiling point	No data available
Flash point	Not applicable
Relative evaporation rate (butylacetate=1)	No data available
Flammability (solid, gas)	No data available
Explosive limits	No data available
Explosive properties	No data available
Oxidising properties	No data available
Vapour pressure	No data available
Relative density	No data available
Relative vapour density at 20 °C	No data available

FS-ONE MAX; CFS-FIL

Safety Data Sheet

according to Federal Register / Vol. 77, No. 58 / Monday, March 26, 2012 / Rules and Regulations

Density	≈ 1.35 g/cm ³
Molecular mass	Not determined
Solubility	No data available
Log Pow	No data available
Auto-ignition temperature	No data available
Decomposition temperature	No data available
Viscosity	No data available
Viscosity, kinematic	No data available
Viscosity, dynamic	No data available

9.2. Other information

VOC content	9 g/l
-------------	-------

SECTION 10: Stability and reactivity

10.1. Reactivity

The product is non-reactive under normal conditions of use, storage and transport.

10.2. Chemical stability

Stable under normal conditions.

10.3. Possibility of hazardous reactions

No dangerous reactions known under normal conditions of use.

10.4. Conditions to avoid

None under recommended storage and handling conditions (see section 7).

10.5. Incompatible materials

No additional information available

10.6. Hazardous decomposition products

Under normal conditions of storage and use, hazardous decomposition products should not be produced.

SECTION 11: Toxicological information

11.1. Information on toxicological effects

Acute toxicity	Not classified
Skin corrosion/irritation	Not classified pH: ≈ 7.85
Serious eye damage/irritation	Not classified pH: ≈ 7.85
Respiratory or skin sensitisation	Not classified
Germ cell mutagenicity	Not classified
Carcinogenicity	Not classified

Quartz (14808-60-7)	
IARC group	1 - Carcinogenic to humans
Reproductive toxicity	Not classified
Specific target organ toxicity (single exposure)	Not classified
Specific target organ toxicity (repeated exposure)	Not classified

FS-ONE MAX; CFS-FIL

Safety Data Sheet

according to Federal Register / Vol. 77, No. 58 / Monday, March 26, 2012 / Rules and Regulations

Aspiration hazard Not classified

SECTION 12: Ecological information

12.1. Toxicity

Ecology - general The product is not considered harmful to aquatic organisms nor to cause long-term adverse effects in the environment.

12.2. Persistence and degradability

No additional information available

12.3. Bioaccumulative potential

No additional information available

12.4. Mobility in soil

No additional information available

12.5. Other adverse effects

Effect on the global warming No known effects from this product.

SECTION 13: Disposal considerations

13.1. Waste treatment methods

Waste treatment methods Dispose of contents/container in accordance with licensed collector's sorting instructions.
 Waste disposal recommendations Dispose in a safe manner in accordance with local/national regulations.

SECTION 14: Transport information

In accordance with ADR / RID / IMDG / IATA / ADN

ADR	IMDG	IATA	RID
14.1. UN number			
Not regulated for transport			
14.2. UN proper shipping name			
Not applicable	Not applicable	Not applicable	Not applicable
14.3. Transport hazard class(es)			
Not applicable	Not applicable	Not applicable	Not applicable
Not applicable	Not applicable	Not applicable	Not applicable
14.4. Packing group			
Not applicable	Not applicable	Not applicable	Not applicable
14.5. Environmental hazards			
Dangerous for the environment : No	Dangerous for the environment : No Marine pollutant : No	Dangerous for the environment : No	Dangerous for the environment : No
No supplementary information available			

FS-ONE MAX; CFS-FIL

Safety Data Sheet

according to Federal Register / Vol. 77, No. 58 / Monday, March 26, 2012 / Rules and Regulations

14.6. Special precautions for user

- **Overland transport**

- **Transport by sea**

No data available

- **Air transport**

No data available

- **Rail transport**

Carriage prohibited (RID) No

14.7. Transport in bulk according to Annex II of MARPOL 73/78 and the IBC Code

SECTION 15: Regulatory information

15.1. US Federal regulations

All components of this product are listed, or excluded from listing, on the United States Environmental Protection Agency Toxic Substances Control Act (TSCA) inventory

15.2. International regulations

CANADA

FS-ONE MAX; CFS-FIL	
WHMIS Classification	Uncontrolled product according to WHMIS classification criteria

EU-Regulations

No additional information available

Classification according to Regulation (EC) No. 1272/2008 [CLP]

Not classified

National regulations

Quartz (14808-60-7)
Listed on IARC (International Agency for Research on Cancer)

15.3. US State regulations

California Proposition 65 - This product does not contain any substances known to the state of California to cause cancer, developmental and/or reproductive harm

SECTION 16: Other information

Revision date 07/04/2017

Full text of H-statements:

H350	May cause cancer
------	------------------

FS-ONE MAX; CFS-FIL

Safety Data Sheet

according to Federal Register / Vol. 77, No. 58 / Monday, March 26, 2012 / Rules and Regulations

NFPA health hazard

0 - Materials that, under emergency conditions, would offer no hazard beyond that of ordinary combustible materials.

NFPA fire hazard

0 - Materials that will not burn under typical dire conditions, including intrinsically noncombustible materials such as concrete, stone, and sand.

NFPA reactivity

0 - Material that in themselves are normally stable, even under fire conditions.

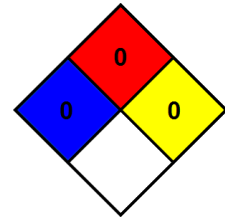

Hazard Rating

Health

0 Minimal Hazard - No significant risk to health

Flammability

0 Minimal Hazard - Materials that will not burn

Physical

0 Minimal Hazard - Materials that are normally stable, even under fire conditions, and will NOT react with water, polymerize, decompose, condense, or self-react. Non-Explosives.

Personal protection

B

B - Safety glasses, Gloves

SDS_US_Hilti

This information is based on our current knowledge and is intended to describe the product for the purposes of health, safety and environmental requirements only. It should not therefore be construed as guaranteeing any specific property of the product



June 17, 2019

To Whom It May Concern:

Re: **Hilti FS-ONE Max Firestop – LEED Info.**

Item Numbers:

2101531
2101532
2101533

The Hilti FS-ONE MAX Firestop is manufactured in the United States

There is no post-consumer or post-industrial recycled content in FS-ONE MAX and it cannot be recycled. The VOC content for FS-ONE MAX is 9 grams/liters.

FS-ONE MAX is not regulated as a hazardous waste by the Federal EPA Standards. The regulations for the disposal of non-regulated industrial waste can vary from state to state and even city to city. For this reason, you should consult your local and state regulatory agencies for direction on disposal.

Please feel free to contact me at (918) 872-3704 if you have questions.

Sincerely,

Jerry Metcalf MPH, CHMM
Sr. Manager, Safety/Environmental
Hilti Inc
(918) 872 3704
jerry.metcalf@hilti.com

Rev. Date: 5/30/19

The manufacturing plant location on this certificate has been provided for LEED reporting purposes only. It should never be used for Country of Origin certification or a representation of compliance/non-compliance with Buy American or Buy America requirements, as those requirements differ.

The manufacturing plant location(s) identified on the certificate represent standard Hilti catalog products only. "Specially" produced non-catalog Hilti products may have differing manufacturing plant locations.

Contact your Hilti representative in cases of "specially" produced products for a custom LEED certificate.

Hilti, Inc.
5400 South 122nd East Avenue
Tulsa, OK 74146
1-800-879-8000
www.hilti.com