



ICC-ES Evaluation Report

ESR-4185

Reissued June 2023

Revised November 2023

This report is subject to renewal June 2025.

DIVISION: 05 00 00—METALS
Section: 05 05 23—Metal Fastenings

REPORT HOLDER:

HILTI, INC.

EVALUATION SUBJECT:

HILTI S-BT AND S-BT HL SCREW-IN FASTENERS

1.0 EVALUATION SCOPE

Compliance with the following codes:

- 2021, 2018, 2015 and 2012 *International Building Code*® (IBC)
- 2021, 2018, 2015 and 2012 *International Residential Code*® (IRC)

For evaluation for compliance with codes adopted by the Los Angeles Department of Building and Safety (LADBS), see [ESR-4185 LABC and LARC Supplement](#).

Property evaluated:

Structural

2.0 USES

The Hilti S-BT and S-BT HL Screw-in Fasteners are used to attach nonstructural components including architectural, mechanical, electrical and similar components, which are not part of the primary load-bearing or lateral-force-resisting systems, to a supporting steel substrate. The fasteners may be used for structures regulated under the IRC, when an engineered design is submitted in accordance with IRC Section R301.1.3.

3.0 DESCRIPTION

3.1 S-BT and S-BT HL Screw-in Fasteners:

Hilti S-BT and S-BT HL Screw-in Fasteners are self-tapping fasteners with a short, blunt threaded portion on one end for embedment into the supporting steel, and a standard thread along the majority of the shank for attachment of supported materials. A sealing washer with a chloroprene rubber (CR) sealing ring is premounted on the tapping end of the fastener. A serrated flange nut is supplied with S-BT and S-BT HL Screw-in Fasteners for multipurpose fastenings (S-BT-M_; S-BT-M HL_;). The S-BT and S-BT HL Screw-in Fasteners for grating fastenings (S-BT-G_; S-BT-G HL_;)

are not supplied with serrated flange nuts and are intended for use in fastening grating.

The S-BT and S-BT HL fasteners must be installed in a predrilled hole. See Table 1 for available fastener materials, thread designations and lengths. See Figure 1 for illustrations of the S-BT fasteners.

3.1.1 S-BT-MR, S-BT-MR HL, S-BT-GR and S-BT-GR HL Screw-in Fasteners:

These fasteners are formed from stainless steel complying with the manufacturer’s specification, with chemical composition of 1.4462 X2CrNiMoN22-5-3, and are zinc plated to facilitate installation. The premounted sealing washer has a diameter of 0.472 inch (12 mm) and is manufactured from SAE 316 stainless steel, bonded to the CR material (denoted by ‘SN’ in the product designation). Serrated flange nuts for the S-BT MR and S-BT MR HL fasteners are also manufactured from stainless steel. Screws with ‘HL’ in the designation have an additional thread forming torque coating to facilitate installation.

3.1.2 S-BT-MF, S-BT-MF HL, S-BT-GF and S-BT-GF HL Screw-in Fasteners:

These fasteners are formed from Grade 1038 carbon steel and have a duplex coating. The coating consists of an electroplated zinc alloy layer and a top coat, with a total coating thickness of 35 µm. The premounted sealing washer has a diameter of 0.394 inch (10 mm) and is manufactured from an aluminum magnesium alloy, bonded to the CR material (denoted by ‘AN’ in the product designation). Serrated flange nuts for the S-BT MF and S-BT MF HL fasteners are manufactured from carbon steel with a hot-dipped galvanized coating. Screws with ‘HL’ in the designation have an additional thread forming torque coating to facilitate installation.

3.2 Steel Substrates:

The supporting steel substrate must be structural steel complying with the minimum strength requirements of ASTM A36; ASTM A572 Grade 50 or ASTM A992, and must have the minimum thickness, yield strength and tensile strength shown in Tables 2 and 3, as applicable.

4.0 DESIGN AND INSTALLATION

4.1 Design:

4.1.1 Allowable Static Loads: The most critical applied loads, excluding seismic load effects, resulting from the load

ICC-ES Evaluation Reports are not to be construed as representing aesthetics or any other attributes not specifically addressed, nor are they to be construed as an endorsement of the subject of the report or a recommendation for its use. There is no warranty by ICC Evaluation Service, LLC, express or implied, as to any finding or other matter in this report, or as to any product covered by the report.

combinations in IBC Section 1605.3.1 or 1605.3.2 must not exceed the allowable loads shown in Tables 2 and 3, as applicable. For fasteners that are subjected to seismic loads, see Section 4.1.3 for additional information. The stress increases and load reductions described in IBC Section 1605.3 are not allowed.

Allowable shear loads and tension (pullout) loads in this report apply to the connection of the fastener to the supporting steel substrate only. Limit states such as pull-over and lateral bearing, which are governed by the properties of attached materials, are outside the scope of this report. Design of the connection of the attached material to the steel substrate, must take into account the properties of the attached material, accounting for interaction between the attached material, the screw-in fastener and the steel substrate, and must comply with the applicable requirements of the IBC.

4.1.2 Combined Loading: For fasteners subjected to both tension and shear loads, compliance with the following interaction equation must be verified:

$$(p/P_a) + (v/V_a) \leq 1$$

where:

- p = Actual applied tension load on fastener, lbf (N).
- P_a = Allowable tension load on fastener, lbf (N).
- v = Actual applied shear load on fastener, lbf (N).
- V_a = Allowable shear load on fastener, lbf (N).

4.1.3 Seismic Considerations: The S-BT and S-BT HL Screw-in Fasteners may be used when subjected to seismic loads, as follows:

1. The fasteners may be used for attachment of non-structural components listed in Section 13.1.4 of ASCE/SEI 7, which are exempt from the requirements of ASCE/SEI 7.
2. When the fasteners listed in Table 1 are installed in steel base materials and subjected to seismic loads, the most critical load applied to each individual fastener must be determined from the equations in IBC Section 1605.3.1 or Section 1605.3.2 which include seismic load effects, and must not exceed the allowable load shown in Table 2 or 3, as applicable.

4.2 Installation:

The S-BT and S-BT HL Screw-in Fasteners must be installed in accordance with this report and the manufacturer's published installation instructions. A copy of these instructions must be available on the jobsite at all times during installation. The installation instructions shown in Figure 5 and 6 are abbreviated instructions and are shown for illustrative purposes only. Installation must be in accordance with the complete installation instructions which accompany the product.

Installation is limited to dry, interior locations, except for stainless steel fasteners, which may be installed in exterior or damp environments, provided the base material is protected from corrosion.

Fastener placement requires a predrilled hole. The hole must be drilled into, but not through, the steel substrate, or must be drilled all the way through the steel substrate, as indicated in Tables 2 and 3. See Figure 2 for an illustration of an S-BT or S-BT HL fastener installed in a hole drilled into the steel and Figure 3 for an illustration of an S-BT or S-BT HL fastener installed in a hole drilled through the steel. The holes must be drilled using a proprietary Hilti drill bit supplied with each package of fasteners. A new bit must be used for

each package of fasteners. In addition to drilling the hole, the drill bit controls the depth of the hole. It also removes any material at the surface of the steel that would interfere with the interface between the fastener and the steel, creating a shiny ring. For the S-BT fasteners, the drilled hole diameter is nominally 5.5 mm. For the S-BT HL fasteners, the drilled hole diameter is nominally 5.3 mm.

After the required hole is drilled, it must be cleaned; the fastener must be installed; and the installation depth must be controlled as illustrated in Figures 5 and 6, as applicable.

For S-BT-M_ and S-BT-M HL_ fasteners, after installation of the supported material, the serrated flange nut must be screwed onto the fastener and tightened to the recommended torque (see Table 4) using a tool in accordance with Hilti, Inc. recommendations. The S-BT-M_ and S-BT-M HL_ fasteners must be installed only with Hilti supplied serrated flange nuts.

For the S-BT-G_ and S-BT-G HL_ fasteners, after installation of the supported grating, a grating disc or similar component must be installed, in accordance with the instructions supplied with this component.

Minimum spacing between fasteners must be 1 inch (25.4 mm) and minimum edge distance must be 1/2 inch (12.7 mm). The installed fasteners must have a stand-off dimension, h_{NVS} , (defined in Figure 2), as stipulated in Table 1. Recommended spacing and edge distances apply to the fasteners installed in the steel base material. Greater spacing and edge distances may be needed due to requirements for the attached material.

5.0 CONDITIONS OF USE

The Hilti S-BT and S-BT HL Screw-in Fasteners described in this report comply with, or are suitable alternatives to what is specified in, those codes listed in Section 1.0 of this report, subject to the following conditions:

- 5.1** Fasteners must be manufactured and identified in accordance with this report.
- 5.2** Fasteners must be installed in accordance with this report and the Hilti, Inc., published installation instructions. In the event of conflict between this report and the Hilti, Inc., published instructions, the more restrictive requirements govern.
- 5.3** Calculations and details demonstrating compliance with the applicable code and this report, including verifying that the applied loads are less than the allowable loads described in Section 4.1, must be submitted to the code official for approval. The calculations and details must be prepared by a registered design professional where required by the statutes of the jurisdiction in which the project is constructed.
- 5.4** Stainless steel fasteners may be installed in exterior, damp environments. Use of carbon steel fasteners is limited to dry, interior locations, which include exterior walls which are protected by an exterior wall envelope.
- 5.5** If the fastener nut or attached materials are removed and replaced, proper thread engagement for the fastener must be reconfirmed in accordance with the Hilti installation instructions.
- 5.6** The Hilti products addressed in this report are manufactured under a quality-control program with inspections by ICC-ES.

6.0 EVIDENCE SUBMITTED

Data in accordance with the ICC-ES Acceptance Criteria for Screw-In Fasteners Installed into Steel Elements (AC499) dated August 2023.

7.0 IDENTIFICATION

- 7.1 The ICC-ES mark of conformity, electronic labeling, or the evaluation report number (ICC-ES ESR-4185) along with the name, registered trademark, or registered logo of the report holder must be included in the product label.
- 7.2 In addition, packages of fasteners bear the product designation. The stainless steel fasteners are imprinted with an “HI” on the end of the fastener, and the carbon steel fasteners are imprinted with “H” on the end of the fastener, as shown in Figure 4.

7.3 The report holder’s contact information is the following:

HILTI, INC.
7250 DALLAS PARKWAY, SUITE 1000
PLANO, TEXAS 75024
(800) 879-8000
www.hilti.com

TABLE 1—S-BT AND S-BT HL SCREW-IN FASTENER DESCRIPTIONS

DESIGNATION	FASTENING THREAD DESIGNATION	NOMINAL FASTENING THREAD LENGTH [inch (mm)]	TAPPING THREAD DIAMETER [inch (mm)]	NOMINAL TAPPING THREAD LENGTH [inch (mm)]	MATERIAL	REQUIRED STAND-OFF, h_{NVS} ¹ [inch (mm)]
S-BT-GR M8/7 SN 6	Metric 8 mm	0.67 (17.05)	0.23 (5.8)	0.24 (6.15)	Stainless Steel	0.732 – 0.752 (18.6 – 19.1)
S-BT-MR W10/15 SN 6	UNC ³ / ₈ -inch	1.09 (27.75)				1.153 – 1.173 (29.3 – 29.8)
S-BT-GF M8/7 AN 6	Metric 8 mm	0.67 (17.05)	0.23 (5.8)	0.24 (6.15)	Carbon Steel	0.732 – 0.752 (18.6 – 19.1)
S-BT-MF W10/15 AN 6	UNC ³ / ₈ -inch	1.09 (27.75)				1.153 – 1.173 (29.3 – 29.8)
S-BT-GR M8/7 SN 6 HL	Metric 8 mm	0.67 (17.05)	0.23 (5.8)	0.24 (6.15)	Stainless Steel	0.732 – 0.752 (18.6 – 19.1)
S-BT-MR M8/15 SN 6 HL	Metric 8 mm	1.09 (27.75)				1.153 – 1.173 (29.3 – 29.8)
S-BT-MR W10/15 SN 6 HL	UNC ³ / ₈ -inch	1.09 (27.75)				1.153 – 1.173 (29.3 – 29.8)
S-BT-MR M10/15 SN 6 HL	Metric 10 mm	1.09 (27.75)	0.23 (5.8)	0.24 (6.15)	Carbon Steel	1.153 – 1.173 (29.3 – 29.8)
S-BT-GF M8/7 AN 6 HL	Metric 8 mm	0.67 (17.05)				0.732 – 0.752 (18.6 – 19.1)
S-BT-MF M8/15 AN 6 HL	Metric 8 mm	1.09 (27.75)				1.153 – 1.173 (29.3 – 29.8)
S-BT-MF W10/15 AN 6 HL	UNC ³ / ₈ -inch	1.09 (27.75)				1.153 – 1.173 (29.3 – 29.8)
S-BT-MF M10/15 AN 6 HL	Metric 10 mm	1.09 (27.75)				1.153 – 1.173 (29.3 – 29.8)

For SI: 1 inch = 25.4 mm.

¹See Figure 2 for depiction of h_{NVS} .

TABLE 2—ALLOWABLE LOADS FOR S-BT AND S-BT HL SCREW-IN FASTENERS INSTALLED INTO ASTM A36 STEEL (lbf)^{1,2}

DESIGNATION	TAPPING THREAD DIAMETER (inch)	STEEL THICKNESS, t (inch)			
		1/8 ≤ t < 1/4 ³		t ≥ 1/4 ⁴	
		Tension	Shear	Tension	Shear
S-BT-GR M8/7 SN 6	0.23	225	340	405	535
S-BT-MR W10/15 SN 6					
S-BT-GF M8/7 AN 6					
S-BT-MF W10/15 AN 6	0.23	225	340	405	450
S-BT-GR M8/7 SN 6 HL					
S-BT-MR M8/15 SN 6 HL					
S-BT-MR W10/15 SN 6 HL					
S-BT-MR M10/15 SN 6 HL	0.23	345	675	640	725
S-BT-MF M8/7 AN 6 HL					
S-BT-MF M8/15 AN 6 HL					
S-BT-MF W10/15 AN 6 HL					
S-BT-MF M10/15 AN 6 HL					
S-BT-MF M10/15 AN 6 HL					

For SI: 1 inch = 25.4 mm, 1 lbf = 4.45 N, 1 ksi = 6.89 MPa.

¹All allowable load capacities above are for installation into steel base material with a minimum yield strength (F_y) of 36 ksi and a minimum tensile strength (F_u) of 58 ksi.

²Allowable loads are applicable to static and seismic loads in accordance with Section 4.1.

³The predrilled hole must extend all the way through the steel base material, and the stand-off dimension, h_{NVS} , must comply with Table 1.

⁴The predrilled hole must extend into the steel base material as far as the drill bit allows, and the stand-off dimension, h_{NVS} , must comply with Table 1.

TABLE 3—ALLOWABLE LOADS FOR S-BT AND S-BT HL SCREW-IN FASTENERS INSTALLED INTO ASTM A572 STEEL (lbf)^{1,2}

DESIGNATION	TAPPING THREAD DIAMETER (inch)	STEEL THICKNESS, t (inch)			
		$1/8 \leq t < 1/4^3$		$t \geq 1/4^4$	
		Tension	Shear	Tension	Shear
S-BT-GR M8/7 SN 6	0.23	295	430	520	600
S-BT-MR W10/15 SN 6					
S-BT-GF M8/7 AN 6	0.23	295	430	520	470
S-BT MF W10/15 AN 6					
S-BT-GR M8/7 SN 6 HL	0.23	380	760	720 ⁵	810
S-BT-MR M8/15 SN 6 HL					
S-BT-MR W10/15 SN 6 HL					
S-BT-MR M10/15 SN 6 HL					
S-BT-GF M8/7 AN 6 HL	0.23	380	510	720	535
S-BT-MF M8/15 AN 6 HL					
S-BT-MF W10/15 AN 6 HL					
S-BT-MF M10/15 AN 6 HL					

For SI: 1 inch = 25.4 mm, 1 lbf = 4.45 N, 1 ksi = 6.89 MPa.

¹All allowable load capacities above are for installation into steel base material with a minimum yield strength (F_y) of 50 ksi and a minimum tensile strength (F_u) of 65 ksi.

²Allowable loads are applicable to static and seismic loads in accordance with Section 4.1, unless otherwise noted.

³The predrilled hole must extend all the way through the steel base material, and the stand-off dimension, h_{NVS} , must comply with Table 1.

⁴The predrilled hole must extend into the steel base material as far as the drill bit allows, and the stand-off dimension, h_{NVS} , must comply with Table 1.

⁵Tabulated value applies to static loads only; for seismic loads, multiple this number by 0.94.

TABLE 4—RECOMMENDED TIGHTENING TORQUE ON SERRATED FLANGE NUT (ft-lbf)

DESIGNATION	STEEL THICKNESS (inch)	
	$1/8 \leq t < 3/16$	$t \geq 3/16$
S-BT-GR M8/7 SN 6	3.6	5.9
S-BT-MR W10/15 SN 6		
S-BT-GF M8/7 AN 6		
S-BT MF W10/15 AN 6		
S-BT-GR M8/7 SN 6 HL	5.9	11.8
S-BT-MR M8/15 SN 6 HL		
S-BT-MR W10/15 SN 6 HL		
S-BT-MR M10/15 SN 6 HL		
S-BT-GF M8/7 AN 6 HL		
S-BT-MF M8/15 AN 6 HL		
S-BT-MF W10/15 AN 6 HL		
S-BT-MF M10/15 AN 6 HL		

For SI: 1 inch = 25.4 mm, 1 ft-lbf = 1.36 Nm.

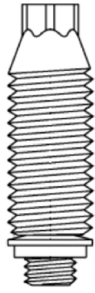

FIGURE 1—HILTI S-BT/S-BT HL SCREW-IN FASTENER WITH SEALING WASHER

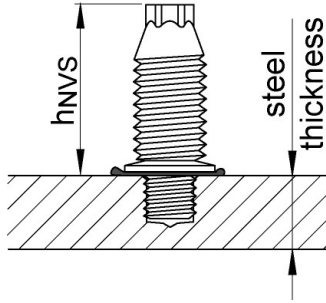

FIGURE 2—DEPICTION OF STAND-OFF DIMENSION, h_{NVS} , AND HOLE DRILLED INTO STEEL BASE MATERIAL

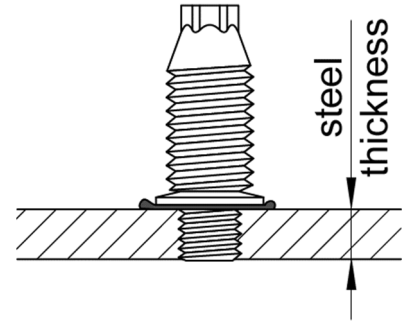
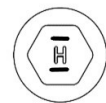

FIGURE 3—DEPICTION OF HOLE DRILLED THROUGH STEEL BASE MATERIAL



S-BT Fasteners



S-BT HL Fasteners

FIGURE 4—DEPICTION OF IDENTIFYING MARKING “HI” FOR HILTI S-BT AND S-BT HL SCREW-IN STAINLESS STEEL FASTENERS, “H” FOR HILTI S-BT AND S-BT HL SCREW-IN CARBON STEEL FASTENERS

<p>Mark location for each fastening</p>	<p>Pre-drill with TS-BT stepped drill bit supplied in the package of fasteners</p>	<p>Screw S-BT HL fasteners into drilled holes</p>	<p>Attach material over the S-BT HL fasteners</p>												
															
	<p>Use Hilti SBT 6-22 Drill Driver:</p> <p>Using “Drill assist” mode. Set the gear selector switch to 2 and BT clutch setting. The speed of the tool reduces automatically when the hole is drilled to the correct depth. A shiny ring should be visible around the borehole after the drilling process.</p>  <p>Before fastener installation:</p> <p>The drilled hole and the area around the drilled hole must be clear of liquids and debris.</p>	<p>Use Hilti SBT 6-22 tool in combination with the stud holder S-SH BT:</p> <p>Use “Fasten S-BT stud” mode. Set the gear selector switch to 1 and BT clutch setting. Insert the S-BT stud into the stud holder. The torque limiter trips when the stud reaches the correct depth.</p> <p>Verify stud standoff h_{NVS} with Hilti check gauge S-IC BT.</p>  <p>Sealing washer must be properly compressed!</p>	<p>Position attached item on S-BT HL fasteners and hold in place. Tighten the nuts or grating fastener with the applicable tightening torque, T_{rec}, from the table below. Tighten the nuts using one of the following:</p> <ul style="list-style-type: none"> • Torque wrench and wrench socket • Torque tool: <ul style="list-style-type: none"> X-BT 1/4” – 8 Nm (for thin base materials) S-BT 1/4” – 16 Nm (for thick base materials) • Drill driver SBT 6-22 and suitable wrench socket S-NS <table border="1" data-bbox="966 1575 1494 1690"> <tr> <td>Steel Thickness (inch)</td> <td>$1/8 \leq t < 3/16$</td> <td>$t \geq 3/16$</td> </tr> <tr> <td>T_{rec} [ft-lbs (Nm)]</td> <td>5.9 (8)</td> <td>11.8 (16)</td> </tr> <tr> <td>Hilti drill driver:</td> <td colspan="2">Clutch setting:</td> </tr> <tr> <td>SBT 6-22</td> <td>3</td> <td>4</td> </tr> </table>	Steel Thickness (inch)	$1/8 \leq t < 3/16$	$t \geq 3/16$	T_{rec} [ft-lbs (Nm)]	5.9 (8)	11.8 (16)	Hilti drill driver:	Clutch setting:		SBT 6-22	3	4
Steel Thickness (inch)	$1/8 \leq t < 3/16$	$t \geq 3/16$													
T_{rec} [ft-lbs (Nm)]	5.9 (8)	11.8 (16)													
Hilti drill driver:	Clutch setting:														
SBT 6-22	3	4													

FIGURE 5—TYPICAL INSTALLATION OF HILTI S-BT HL SCREW-IN FASTENERS

① Mark location for each fastening	② Pre-drill with TS-BT stepped drill bit supplied in the package of fasteners	③ Screw S-BT fasteners into drilled holes	④ Attach material over the S-BT or S-BT HL fasteners																							
																										
<p>Use Hilti SBT 4-A22, SF BT 18-A or SF BT 22-A tool.</p> <p>Pre-drill until the shoulder grinds a shiny ring to ensure proper drilling depth, as shown below.</p>  <p>Before fastener installation: The drilled hole and the area around the drilled hole must be clear of liquids and debris.</p> <p>In the case of a hole through the steel, rework of the coating on the back side of the plate / profile may be needed.</p>	<p>Use a Hilti SBT 4-A22, SFC 18-A or SFC 22-A tool in combination with the Hilti calibrated depth gauge S-DG BT.</p> <p>Verify fastener stand-off dimension, h_{NVS}, with check gauge S-CG BT.</p>  <p>Sealing washer must be properly compressed!</p>	<p>Position attached item on S-BT fasteners and hold in place. Tighten the nuts with the applicable tightening torque T_{rec}, from the table below.</p> <p>Tighten the nuts using one of the following:</p> <ul style="list-style-type: none"> • SBT 4-A22, SFC 18-A / 22-A with socket S-NS (S-BT fasteners only) • Depending on required torque: Torque tool S-BT 1/4" - 5 Nm Torque tool X-BT 1/4" - 8 Nm Torque Tool S-BT 1/4" - 16 Nm • torque wrench 	<table border="1"> <thead> <tr> <th colspan="2">Steel Thickness (inch)</th> <th>$1/8 \leq t < 3/16$</th> <th>$t \geq 3/16$</th> </tr> </thead> <tbody> <tr> <td rowspan="2">T_{rec} [ft-lbs (Nm)]</td> <td>S-BT</td> <td>3.6 (5)</td> <td>5.9 (8)</td> </tr> <tr> <td>S-BT HL</td> <td>5.9 (8)</td> <td>11.8 (16)</td> </tr> </tbody> </table> <table border="1"> <thead> <tr> <th>Hilti drill driver:*</th> <th colspan="2">Torque setting on tool:*</th> </tr> </thead> <tbody> <tr> <td>SBT 4-A22</td> <td>5</td> <td>7</td> </tr> <tr> <td>SFC 18-A</td> <td>4</td> <td>5</td> </tr> <tr> <td>SFC 22-A</td> <td>4</td> <td>5</td> </tr> </tbody> </table> <p>*Applies to S-BT fasteners only.</p>	Steel Thickness (inch)		$1/8 \leq t < 3/16$	$t \geq 3/16$	T_{rec} [ft-lbs (Nm)]	S-BT	3.6 (5)	5.9 (8)	S-BT HL	5.9 (8)	11.8 (16)	Hilti drill driver:*	Torque setting on tool:*		SBT 4-A22	5	7	SFC 18-A	4	5	SFC 22-A	4	5
Steel Thickness (inch)		$1/8 \leq t < 3/16$	$t \geq 3/16$																							
T_{rec} [ft-lbs (Nm)]	S-BT	3.6 (5)	5.9 (8)																							
	S-BT HL	5.9 (8)	11.8 (16)																							
Hilti drill driver:*	Torque setting on tool:*																									
SBT 4-A22	5	7																								
SFC 18-A	4	5																								
SFC 22-A	4	5																								

FIGURE 6—TYPICAL INSTALLATION OF HILTI S-BT SCREW-IN FASTENERS (ALTERNATE INSTALLATION OF HILTI S-BT HL FASTENERS)

DIVISION: 05 00 00—METALS**Section: 05 05 23—Metal Fastenings****REPORT HOLDER:**

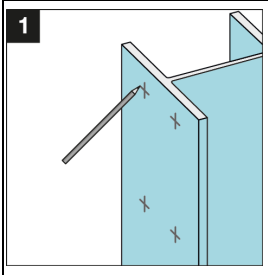
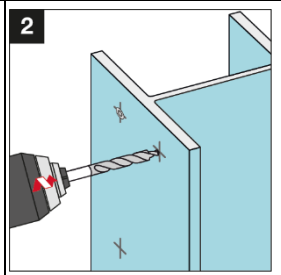
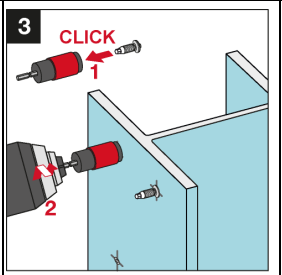
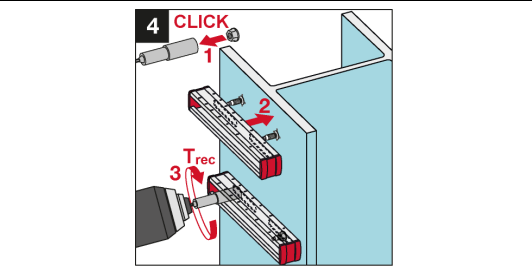
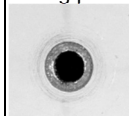
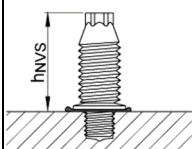
HILTI, INC.

EVALUATION SUBJECT:

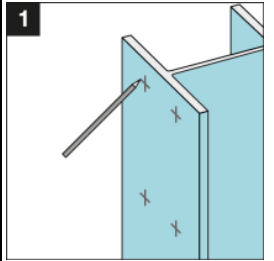
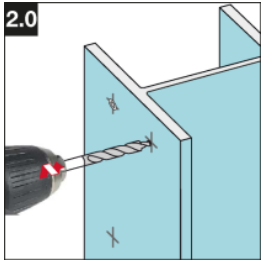
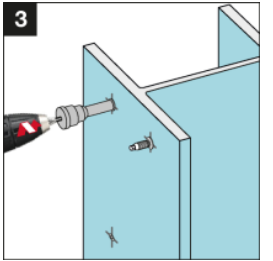
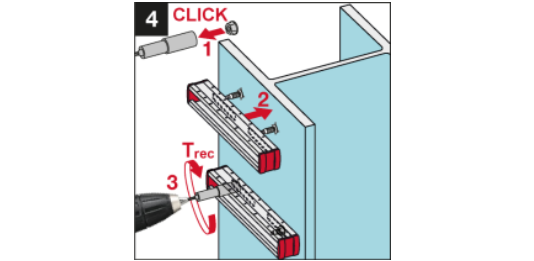
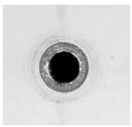
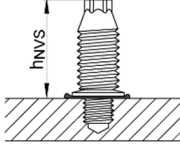
HILTI S-BT AND S-BT HL SCREW-IN FASTENERS

1.0 REPORT PURPOSE AND SCOPE**Purpose:**

The purpose of this evaluation report supplement is to indicate that the Hilti S-BT and S-BT HL Screw-in Fasteners, described in ICC-ES evaluation report [ESR-4185](#), have also been evaluated for compliance with the codes noted below as adopted by the Los Angeles Department of Building and Safety (LADBS).

Applicable code editions:

- 2023 *City of Los Angeles Building Code* (LABC)
- 2023 *City of Los Angeles Residential Code* (LARC)

2.0 CONCLUSIONS

The Hilti S-BT and S-BT HL Screw-in Fasteners, described in Sections 2.0 through 7.0 of the evaluation report [ESR-4185](#), comply with the LABC Chapter 22, and the LARC, and are subject to the conditions of use described in this supplement.

3.0 CONDITIONS OF USE

The Hilti S-BT and S-BT HL Screw-in Fasteners described in this evaluation report supplement must comply with all of the following conditions:

- All applicable sections in the evaluation report [ESR-4185](#).
- The design, installation, conditions of use and identification of the Hilti S-BT and S-BT HL Screw-in Fasteners are in accordance with the 2021 *International Building Code*® (IBC) provisions noted in the evaluation report [ESR-4185](#).
- The design, installation and inspection are in accordance with additional requirements of LABC Chapters 16 and 17, as applicable.
- Under the LARC, an engineered design in accordance with LARC Section R301.1.3 must be submitted.
- The allowable strength values listed in the evaluation report and tables are for the connection of the screw-in fasteners to steel substrate. The connection between the screw-in fasteners and the attached building material must be checked for capacity (which may govern).

This supplement expires concurrently with the evaluation report, reissued June 2023 and revised November 2023.

DIVISION: 05 00 00—METALS**Section: 05 05 23—Metal Fastenings****REPORT HOLDER:**

HILTI, INC.

EVALUATION SUBJECT:

HILTI S-BT AND S-BT HL SCREW-IN FASTENERS

1.0 REPORT PURPOSE AND SCOPE**Purpose:**

The purpose of this evaluation report supplement is to indicate that Hilti S-BT and S-BT HL Screw-in Fasteners, described in ICC-ES evaluation report ESR-4185, have also been evaluated for compliance with the codes noted below.

Applicable code editions:

- 2023 *Florida Building Code—Building*
- 2023 *Florida Building Code—Residential*

2.0 CONCLUSIONS

The Hilti S-BT and S-BT HL Screw-in Fasteners, described in Sections 2.0 through 7.0 of ICC-ES evaluation report ESR-4185, comply with the *Florida Building Code—Building* and the *Florida Building Code—Residential*. The design requirements must be determined in accordance with the *Florida Building Code—Building* or the *Florida Building Code—Residential*, as applicable. The installation requirements noted in ICC-ES evaluation report ESR-4185 for the 2021 *International Building Code*® meet the requirements of the *Florida Building Code—Building* or the *Florida Building Code—Residential*, as applicable.

Use of the Hilti S-BT and S-BT HL Screw-in Fasteners has also been found to be in compliance with the High-Velocity Hurricane Zone provisions of the *Florida Building Code—Building* and the *Florida Building Code—Residential*, with the following condition:

- a) For connections subject to uplift, the connection must be designed for no less than 700 pounds (3114 N).

For products falling under Florida Rule 61G20-3, verification that the report holder's quality-assurance program is audited by a quality-assurance entity approved by the Florida Building Commission for the type of inspections being conducted is the responsibility of an approved validation entity (or the code official, when the report holder does not possess an approval by the Commission).

This supplement expires concurrently with the evaluation report, reissued June 2023 and revised November 2023.