



Anchor Fastening Technology Manual

Hilti

Stud anchor

**Carbon steel and
stainless steel**

HSA

HSA-BW

HSA-R2

HSA-R

**Hot dipped
galvanized**

HSA-F

M6 – M20

HSA Stud anchor

	Anchor version	Benefits
	HSA Carbon steel with DIN 125 washe	<ul style="list-style-type: none"> - Fast & convenient setting behaviour - Reliable ETA approved torqueing using impact wrench with torque bar for torque control - Small edge and spacing distances - High loads - Three embedment depths for maximal design flexibility - M12, M16 and M20 ETA approved for diamond cored holes using DD 30-W and matching diamond core bit - Suitable for pre- and through fastening
	HSA-R Stainless steel A4 HSA-R2 Stainless steel A2 with DIN 125 washer	
	HSA-BW Carbon steel with DIN 9021 washer	

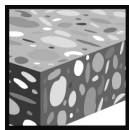

Concrete



Small edge distance and spacing



Fire resistance



Corrosion resistance

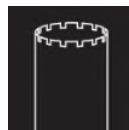

Diamond drilled holes



European Technical Approval



CE conformity



PROFIS Anchor design software

Approvals / certificates

Description	Authority / Laboratory	No. / date of issue
European technical approval ^{a)}	DIBt, Berlin	ETA-11/0374 / 2012-07-19
Fire test report	IBMB, Braunschweig	3215/229/12 / 2012-08-09

a) All data given in this section according ETA-11/0374, issue 2012-07-19.

Basic loading data (for a single anchor)

All data in this section applies to

- Correct setting (See setting instruction)
- No edge distance and spacing influence
- Steel failure
- Minimum base material thickness
- Non-cracked Concrete C 20/25, $f_{ck,cube} = 25 \text{ N/mm}^2$

For details see Simplified design method

Mean ultimate resistance

Anchor size			M6			M8			M10		
Effective anchorage depth	h_{ef}	[mm]	30	40	60	30	40	70	40	50	80
Tensile $N_{Ru,m}$											
HSA, HSA-BW	[kN]		8,0	9,5	9,5	11,0	17,0	17,3	17,0	23,7	29,4
HSA-R2, HSA-R	[kN]		8,0	10,0	11,9	11,0	17,0	19,2	17,0	23,7	33,2
Shear $V_{Ru,m}$											
HSA, HSA-BW	[kN]		6,8	6,8	6,8	11,0	11,1	11,1	19,8	19,8	19,8
HSA-R2, HSA-R	[kN]		7,6	7,6	7,6	11,0	12,9	12,9	23,7	23,7	23,7

Anchor size			M12			M16			M20		
Effective anchorage depth	h_{ef}	[mm]	50	65	100	65	80	120	75	100	115
Tensile $N_{Ru,m}$											
HSA, HSA-BW	[kN]		23,7	35,1	43,5	35,1	48,0	66,4	43,5	67,0	82,7
HSA-R2, HSA-R	[kN]		23,7	35,1	46,5	35,1	48,0	66,4	43,5	67,0	82,7
Shear $V_{Ru,m}$											
HSA, HSA-BW	[kN]		31,0	31,0	31,0	53,6	53,6	53,6	87,1	90,1	90,1
HSA-R2, HSA-R	[kN]		30,8	30,8	30,8	59,3	59,3	59,3	87,1	96,5	96,5

Characteristic resistance

Anchor size			M6			M8			M10		
Effective anchorage depth	h_{ef}	[mm]	30	40	60	30	40	70	40	50	80
Tensile N_{Rk}											
HSA, HSA-BW	[kN]		6,0	7,5	9,0	8,3	12,8	16,0	12,8	17,9	25,0
HSA-R2, HSA-R	[kN]		6,0	7,5	9,0	8,3	12,8	16,0	12,8	17,9	25,0
Shear V_{Rk}											
HSA, HSA-BW	[kN]		6,5	6,5	6,5	8,3	10,6	10,6	18,9	18,9	18,9
HSA-R2, HSA-R	[kN]		7,2	7,2	7,2	8,3	12,3	12,3	22,6	22,6	22,6

Anchor size			M12			M16			M20		
Effective anchorage depth	h_{ef}	[mm]	50	65	100	65	80	120	75	100	115
Tensile N_{Rk}											
HSA, HSA-BW	[kN]		17,9	26,5	35,0	26,5	36,1	50,0	32,8	50,5	62,3
HSA-R2, HSA-R	[kN]		17,9	26,5	35,0	26,5	36,1	50,0	32,8	50,5	62,3
Shear V_{Rk}											
HSA, HSA-BW	[kN]		29,5	29,5	29,5	51,0	51,0	51,0	65,6	85,8	85,8
HSA-R2, HSA-R	[kN]		29,3	29,3	29,3	56,5	56,5	56,5	65,6	91,9	91,9

Design resistance

Anchor size			M6			M8			M10		
Effective anchorage depth	h_{ef}	[mm]	30	40	60	30	40	70	40	50	80
Tensile N_{Rd}											
HSA, HSA-BW	[kN]		4,0	5,0	6,0	5,5	8,5	10,7	8,5	11,9	16,7
HSA-R2, HSA-R	[kN]		4,0	5,0	6,0	5,5	8,5	10,7	8,5	11,9	16,7
Shear V_{Rd}											
HSA, HSA-BW	[kN]		5,2	5,2	5,2	5,5	8,5	8,5	15,1	15,1	15,1
HSA-R2, HSA-R	[kN]		5,5	5,8	5,8	5,5	9,8	9,8	18,1	18,1	18,1

Anchor size			M12			M16			M20		
Effective anchorage depth	h_{ef}	[mm]	50	65	100	65	80	120	75	100	115
Tensile N_{Rd}											
HSA, HSA-BW	[kN]		11,9	17,6	23,3	17,6	24,1	33,3	21,9	33,7	41,5
HSA-R2, HSA-R	[kN]		11,9	17,6	23,3	17,6	24,1	33,3	21,9	33,7	41,5
Shear V_{Rd}											
HSA, HSA-BW	[kN]		23,6	23,6	23,6	40,8	40,8	40,8	43,7	68,6	68,6
HSA-R2, HSA-R	[kN]		23,4	23,4	23,4	45,2	45,2	45,2	43,7	73,5	73,5

Recommended loads

Anchor size			M6			M8			M10		
Effective anchorage depth	h_{ef}	[mm]	30	40	60	30	40	70	40	50	80
Tensile N_{rec}^a											
HSA, HSA-BW	[kN]		2,9	3,6	4,3	4,0	6,1	7,6	6,1	8,5	11,9
HSA-R2, HSA-R	[kN]		2,9	3,6	4,3	4,0	6,1	7,6	6,1	8,5	11,9
Shear V_{rec}^a											
HSA, HSA-BW	[kN]		3,7	3,7	3,7	4,0	6,1	6,1	10,8	10,8	10,8
HSA-R2, HSA-R	[kN]		4,0	4,1	4,1	4,0	7,0	7,0	12,9	12,9	12,9

Anchor size			M12			M16			M20		
Effective anchorage depth	h_{ef}	[mm]	50	65	100	65	80	120	75	100	115
Tensile N_{rec}^a											
HSA, HSA-BW	[kN]		8,5	12,6	16,7	12,6	17,2	23,8	15,6	24,0	29,7
HSA-R2, HSA-R	[kN]		8,5	12,6	16,7	12,6	17,2	23,8	15,6	24,0	29,7
Shear V_{rec}^a											
HSA, HSA-BW	[kN]		16,9	16,9	16,9	29,1	29,1	29,1	31,2	49,0	49,0
HSA-R2, HSA-R	[kN]		16,7	16,7	16,7	32,3	32,3	32,3	31,2	52,5	52,5

a) With overall partial safety factor for action $\gamma = 1,4$. The partial safety factors for action depend on the type of loading and shall be taken from national regulations.

Materials

Mechanical properties

Anchor size			M6	M8	M10	M12	M16	M20
Nominal tensile strength $f_{uk,thread}$	HSA HSA-BW	[N/mm ²]	650	580	650	700	650	700
	HSA-R2 HSA-R	[N/mm ²]	650	560	650	580	600	625
Yield strength $f_{yk,thread}$	HSA HSA-BW	[N/mm ²]	520	464	520	560	520	560
	HSA-R2 HSA-R	[N/mm ²]	520	448	520	464	480	500
Stressed cross-section $A_{s,thread}$	HSA HSA-BW HSA-R2 HSA-R	[mm ²]	20,1	36,6	58,0	84,3	157,0	245,0
Moment of resistance W	HSA HSA-BW HSA-R2 HSA-R	[mm ³]	12,7	31,2	62,3	109,2	277,5	540,9
Char. bending resistance $M_{Rk,s}^0$	HSA HSA-BW	[Nm]	9,9	21,7	48,6	91,7	216,4	454,4
	HSA-R2 HSA-R	[Nm]	9,9	21,0	48,6	76,0	199,8	405,7

Material quality

Type	Part	Material	Coating
HSA HSA-BW Carbon Steel	Bolt	Carbon-steel	Galvanized ($\geq 5 \mu\text{m}$)
	Sleeve	Carbon-steel	
	Washer	HSA :carbon steel, HSA-BW: carbon steel	
	Hexagon nut	Steel, strength class 8	
HSA-R2 Stainless Steel Grade A2	Bolt	Stainless steel A2, 1.4301 or 1.4162	M6 - M20 coated
	Sleeve	Stainless steel A2, 1.4301 or 1.4404	-
	Washer	Stainless steel grade A2	-
	Hexagon nut	Stainless steel grade A2	M6 - M20 coated
HSA-R Stainless Steel Grade A4	Bolt	Stainless steel grade A4, 1.4401 or 1.4362	M6 - M20 coated
	Sleeve	Stainless steel A2, 1.4301 or 1.4404	-
	Washer	Stainless steel grade A4	-
	Hexagon nut	Stainless steel grade A4	M6 - M20 coated

Geometry washer

Anchor Size		M6	M8	M10	M12	M16	M20
Inner diameter d_1							
HSA, HSA-R2/ R	d_1 [mm]	6,4	8,4	10,5	13,0	17,0	21
HSA-BW	d_1 [mm]	6,4	8,4	10,5	13,0	17,0	22
Outer diameter d_2							
HSA, HSA-R2/ R	d_2 [mm]	12,0	16,0	20,0	24,0	30,0	37,0
HSA-BW	d_2 [mm]	18,0	24,0	30,0	37,0	50,0	60,0
Thickness h							
HSA, HSA-R2/ R	h [mm]	1,6	1,6	2,0	2,5	3,0	3,0
HSA-BW	h [mm]	1,8	2,0	2,5	3,0	3,0	4,0

Anchor dimensions and coding

Product marking and identification of anchor

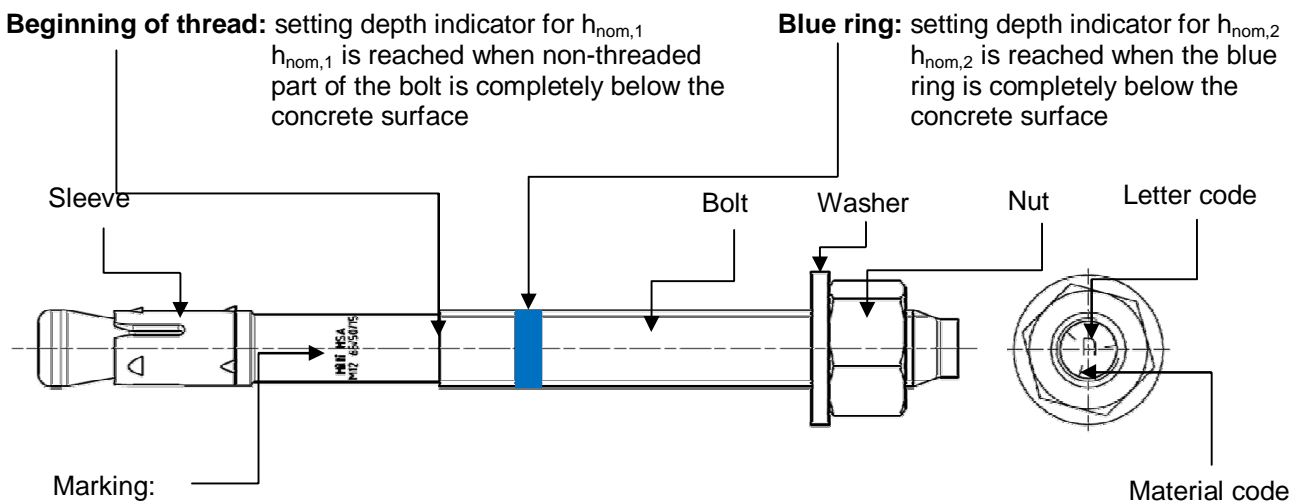

e.g.
 Hilti HSA ... Brand and Anchor type
 M12 65/50/15 ... Anchor Size and the max. $t_{fix,1}/ t_{fix,2}/ t_{fix,3}$ for the corresponding $h_{nom,1}/ h_{nom,2}/ h_{nom,3}$

Material code for identification of different materials

Type	HSA/ HSA-BW (carbon steel)	HSA-R2 (stainless steel grade A2)	HSA-R (stainless steel grade A4)
Material Code	 Letter code without mark	 Letter code with two marks	 Letter code with three marks

Effective and nominal anchorage depth

Anchor size			M6			M8			M10		
Effective anchorage depth	h_{ef}	[mm]	30	40	60	30	40	70	40	50	80
Nominal anchorage depth	h_{nom}	[mm]	37	47	67	39	49	79	50	60	90

Anchor size			M12			M16			M20		
Effective anchorage depth	h_{ef}	[mm]	50	65	100	65	80	120	75	100	115
Nominal anchorage depth	h_{nom}	[mm]	64	79	114	77	92	132	90	115	130

Letter code for anchor length and maximum thickness of the fixture t_{fix}

Type	HSA, HSA-BW, HSA-R2, HSA-R					
Size	M6	M8	M10	M12	M16	M20
h_{nom} [mm]	37 / 47 / 67	39 / 49 / 79	50 / 60 / 90	64 / 79 / 114	77 / 92 / 132	90 / 115 / 130
Letter t_{fix}	$t_{fix,1}/t_{fix,2}/t_{fix,3}$	$t_{fix,1}/t_{fix,2}/t_{fix,3}$	$t_{fix,1}/t_{fix,2}/t_{fix,3}$	$t_{fix,1}/t_{fix,2}/t_{fix,3}$	$t_{fix,1}/t_{fix,2}/t_{fix,3}$	$t_{fix,1}/t_{fix,2}/t_{fix,3}$
<u>z</u>	5/-/-	5/-/-	5/-/-	5/-/-	5/-/-	5/-/-
<u>y</u>	10/-/-	10/-/-	10/-/-	10/-/-	10/-/-	10/-/-
<u>x</u>	15/5/-	15/5/-	15/5/-	15/-/-	15/-/-	15/-/-
<u>w</u>	20/10/-	20/10/-	20/10/-	20/5/-	20/5/-	20/-/-
<u>v</u>	25/15/-	25/15/-	25/15	25/10/-	25/10/-	25/-/-
<u>u</u>	30/20/-	30/20/-	30/20/-	30/15/-	30/15/-	30/5/-
<u>t</u>	35/25/5	35/25/-	35/25/-	35/20/-	35/20/-	35/10/-
<u>s</u>	40/30/10	40/30/-	40/30/-	40/25/-	40/25/-	40/15/-
<u>r</u>	45/35/15	45/35/5	45/35/5	45/30/-	45/30/-	45/20/5
<u>q</u>	50/40/20	50/40/10	50/40/10	50/35/-	50/35/-	50/25/10
<u>p</u>	55/45/25	55/45/15	55/45/15	55/40/5	55/40/-	55/30/15
<u>o</u>	60/50/30	60/50/20	60/50/20	60/45/10	60/45/5	60/35/20
<u>n</u>	65/55/35	65/55/25	65/55/25	65/50/15	65/50/10	65/40/25
<u>m</u>	70/60/40	70/60/30	70/60/30	70/55/20	70/55/15	70/45/30
<u>l</u>	75/65/45	75/65/35	75/65/35	75/60/25	75/60/20	75/50/35
<u>k</u>	80/70/50	80/70/40	80/70/40	80/65/30	80/65/25	80/55/40
<u>j</u>	85/75/55	85/75/45	85/75/45	85/70/35	85/70/30	85/60/45
<u>i</u>	90/80/60	90/80/50	90/80/50	90/75/40	90/75/35	90/65/50
<u>h</u>	95/85/65	95/85/55	95/85/55	95/80/45	95/80/40	95/70/55
<u>g</u>	100/90/70	100/90/60	100/90/60	100/85/50	100/85/45	100/75/60
<u>f</u>	105/95/75	105/95/65	105/95/65	105/90/55	105/90/50	105/80/65
<u>e</u>	110/100/80	110/100/70	110/100/70	110/95/60	110/95/55	110/85/70
<u>d</u>	115/105/85	115/105/75	115/105/75	115/100/65	115/100/60	115/90/75
<u>c</u>	120/110/90	120/110/80	120/110/80	125/110/75	120/105/65	120/95/80
<u>b</u>	125/115/95	125/115/85	125/115/85	135/120/85	125/110/70	125/100/85
<u>a</u>	130/120/100	130/120/90	130/120/90	145/130/95	135/120/80	130/105/90

Anchor length in bolt type and grey shaded are standard items. For selection of other anchor length, check availability of the items.

Setting

Installation equipment

Anchor size	M6	M8	M10	M12	M16	M20
Rotary hammer	TE2 – TE16					TE40 – TE70
Other tools	hammer, torque wrench, blow out pump					

Setting instruction

Drill and clean borehole

Standard drilling method
M6 – M20: Hammer drilling (HD)

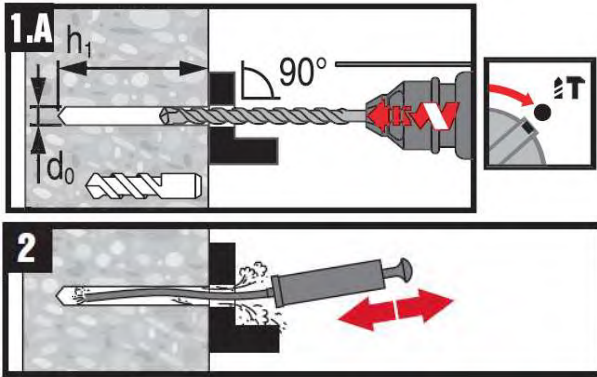

Alternative drilling method
M12 – M20: Diamond drilling (DD)

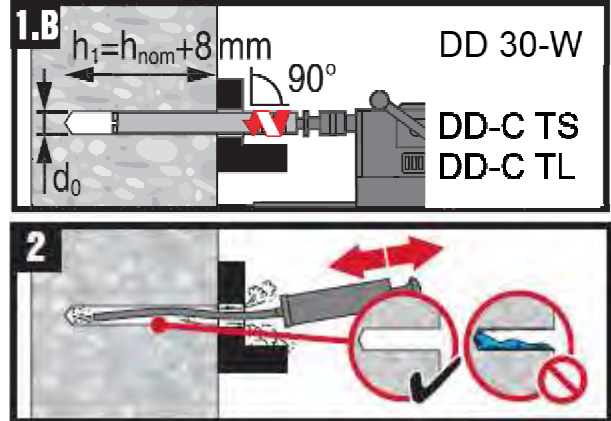

Install anchor with hammer or machine setting tool

Standard setting method
M6 – M20: Hammer setting

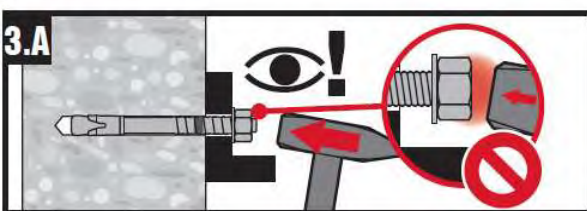

Alternative setting method
M8 – M16: Machine setting

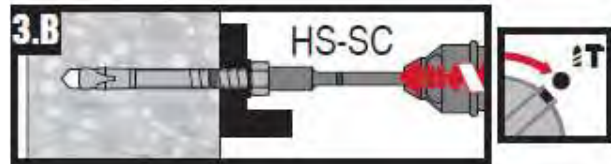

Check setting

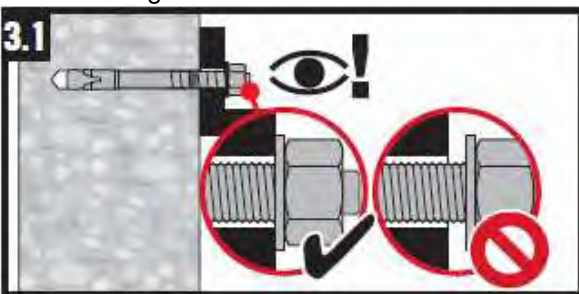

Tightening the anchor

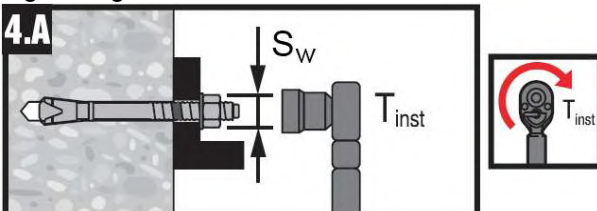

For detailed information on installation see instruction for use given with the package of the product.

Machine tightening of the anchor for standard installation torque

Type	HSA, HSA-BW, HSA-R2, HSA-R																	
Anchor Size	M6			M8			M10			M12			M16			M20		
Setting position	①	②	③	①	②	③	①	②	③	①	②	③	①	②	③	①	②	③
Nominal anchorage depth h_{nom} [mm]	37	47	67	39	49	79	50	60	90	64	79	114	77	92	132	90	115	130
Standard installation torque T_{inst} [Nm]	-			15			25			50			80			-		
Setting tool	-			S-TB HSA M8			S-TB HSA M10			S-TB HSA M12			S-TB HSA M16			-		
Impact screw driver	-			Hilti SIW 14-A Hilti SIW 22-A									Hilti SIW 22T-A			-		
Speed	-			1			1			3			- ¹⁾			-		
	HSA, HSA-BW			HSA-R2, HSA-R														
Setting time t_{set} [sec.]	-			-			-			4			-			-		

¹⁾ The impact screw driver operates with a fixed speed.

Setting instruction for HSA, HSA-BW, HSA-R2 and HSA-R M8 – M16

Tightening the anchor - alternatively with impact screw driver and special socket

Selecting the impact screw driver, battery and special socket

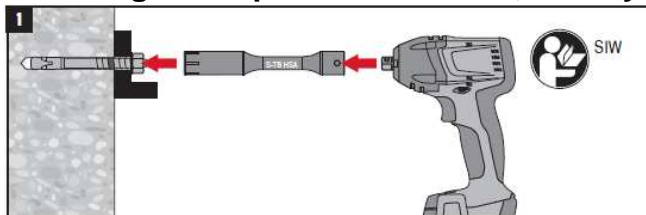

			S-TB HSA M8	S-TB HSA M10	S-TB HSA M12	S-TB HSA M16
SIW 14-A	14V	1.6Ah / 3.3Ah	✓	✓	✓	-
SIW 22-A	22V	1.6Ah / 2.6Ah / 3.3Ah	✓	✓	✓	-
SIW 22T-A	22V	2.6Ah / 3.3Ah	-	-	-	✓

Selecting the speed setting and state of charge of the battery

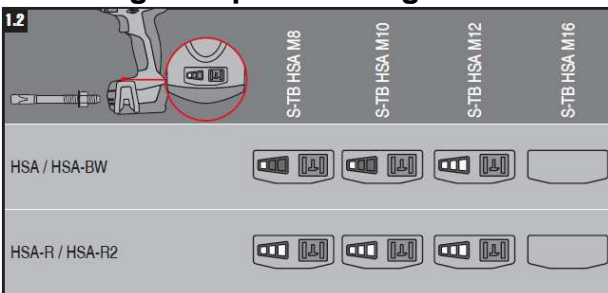

	≤ 5°	5° ... 10°	≥ 10°
	-	-	-
	-	-	✓
	-	-	✓
	-	✓	✓

Tighten the anchor and check the installation

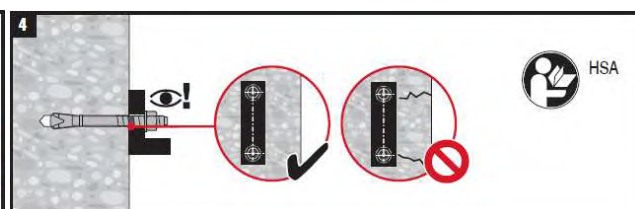
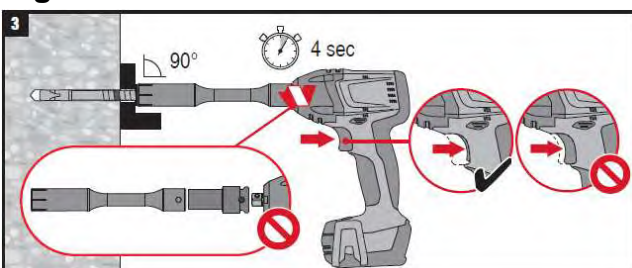

For detailed information on installation see instruction for use given with the package of the product.

Setting details

One anchor length for different fixture thickness t_{fix} and the corresponding setting positions

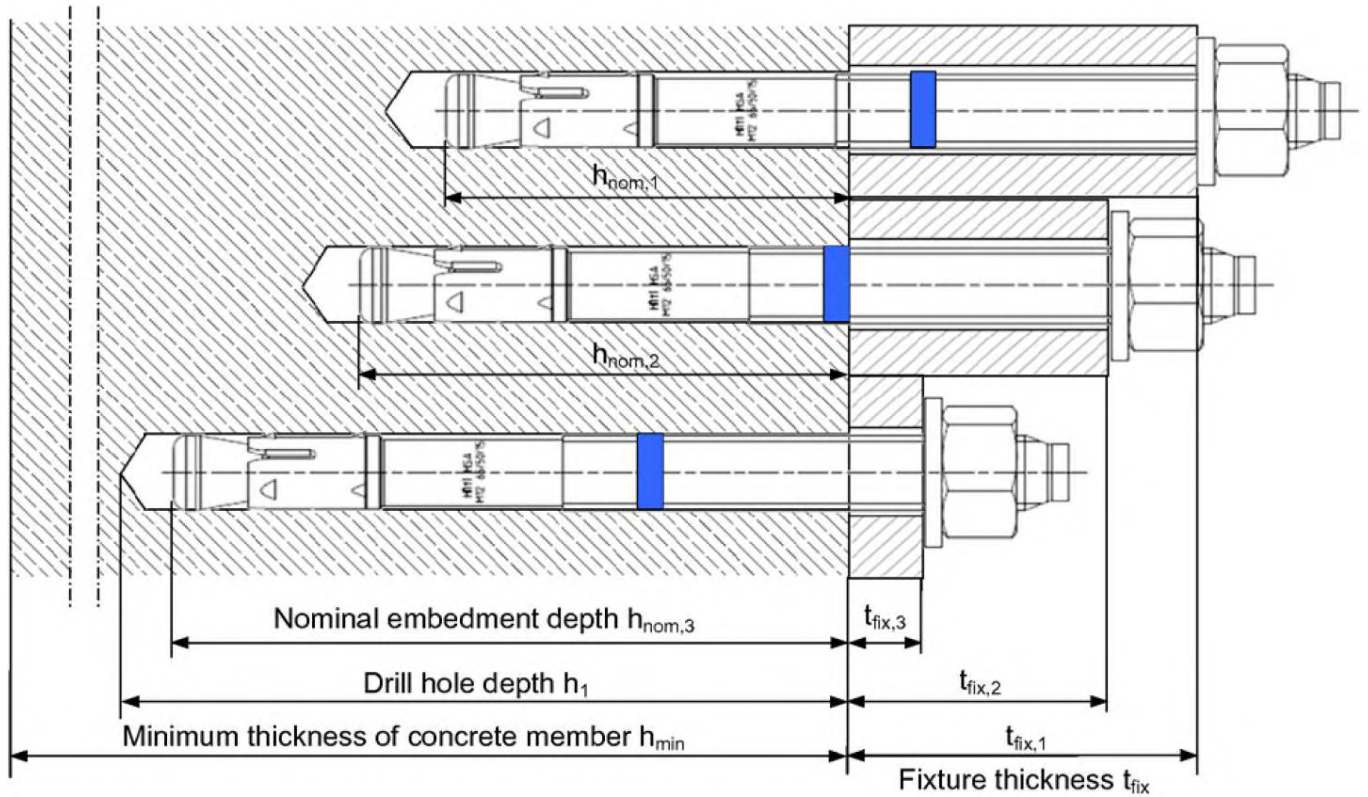

Different anchor length for different setting positions and the corresponding fixture thickness t_{fix}

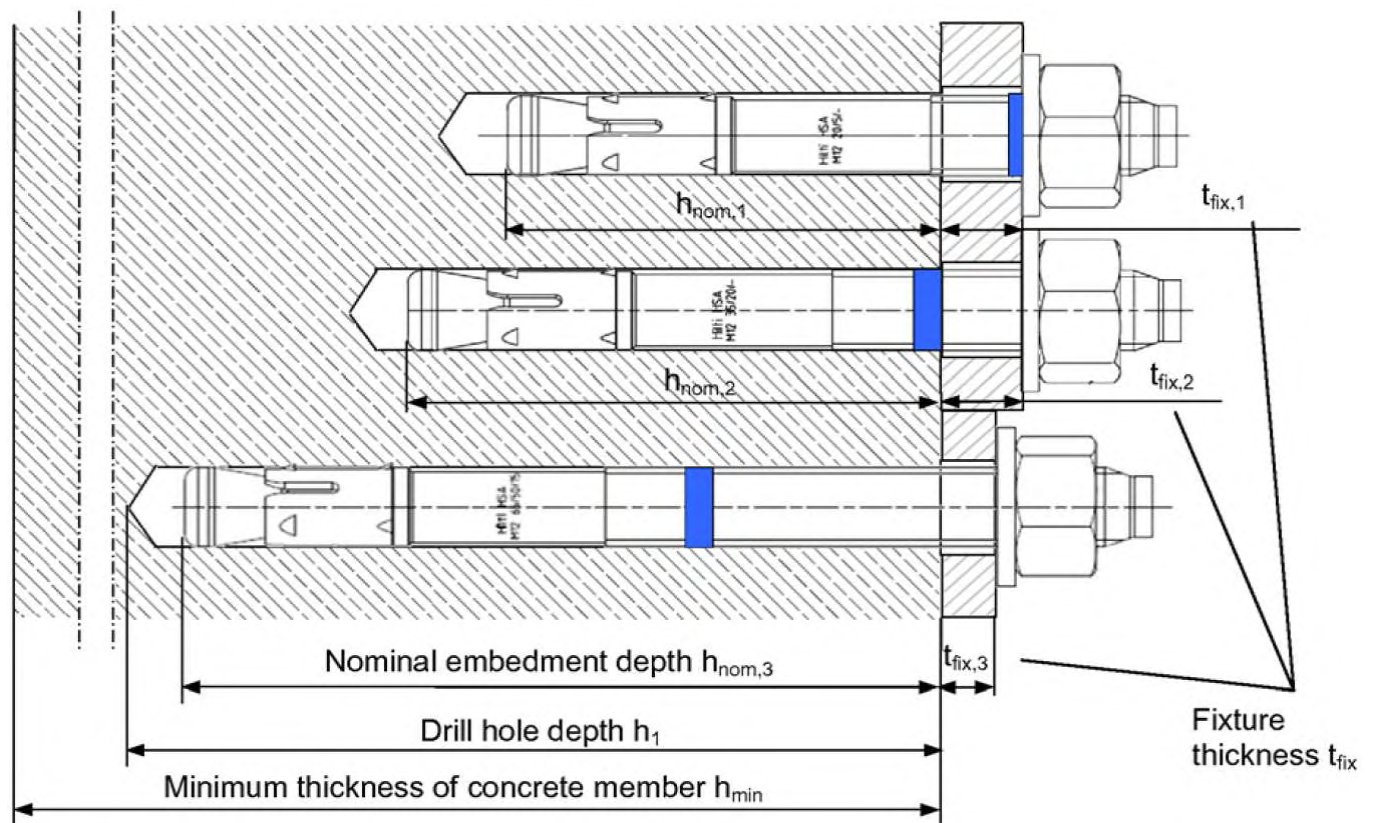

Setting details

Anchor size		M6			M8			M10		
Nominal anchorage depth	h_{nom} [mm]	37	47	67	39	49	79	50	60	90
Minimum base material thickness	h_{min} [mm]	100	100	120	100	100	120	100	120	160
Minimum spacing	s_{min} [mm]	35	35	35	35	35	35	50	50	50
Minimum edge distance	c_{min} [mm]	35	35	35	40	35	35	50	40	40
Nominal diameter of drill bit	d_o [mm]	6			8			10		
Cutting diameter of drill bit	$d_{cut} \leq$ [mm]	6,4			8,45			10,45		
Depth of drill hole	$h_1 \geq$ [mm]	42	52	72	44	54	84	55	65	95
Diameter of clearance hole in the fixture	$d_f \leq$ [mm]	7			9			12		
Torque moment	T_{inst} [Nm]	5			15			25		
Width across	SW [mm]	10			13			17		

Anchor size		M12			M16			M20		
Nominal anchorage depth	h_{nom} [mm]	64	79	114	77	92	132	90	115	130
Minimum base material thickness	h_{min} [mm]	100	140	180	140	160	180	160	220	220
Minimum spacing	s_{min} [mm]	70	70	70	90	90	90	195	175	175
Minimum edge distance	c_{min} [mm]	70	65	55	80	75	70	130	120	120
Nominal diameter of drill bit	d_o [mm]	12			16			20		
Cutting diameter of drill bit	$d_{cut} \leq$ [mm]	12,5			16,5			20,55		
Depth of drill hole	$h_1 \geq$ [mm]	72	87	122	85	100	140	98	123	138
Diameter of clearance hole in the fixture	$d_f \leq$ [mm]	14			18			22		
Torque moment	T_{inst} [Nm]	50			80			200		
Width across	SW [mm]	19			24			30		

Design parameters

Anchor size		M6			M8			M10		
Nominal anchorage depth	h_{nom} [mm]	37	47	67	39	49	79	50	60	90
Effective anchorage depth	h_{ef} [mm]	30	40	60	30	40	70	40	50	80
Critical spacing for splitting failure	$s_{cr,sp}$ [mm]	100	120	130	130	180	200	190	210	290
Critical edge distance for splitting failure	$c_{cr,sp}$ [mm]	50	60	65	65	90	100	95	105	145
Critical spacing for concrete cone failure	$s_{cr,N}$ [mm]	90	120	180	90	120	210	120	150	240
Critical edge distance for concrete cone failure	$c_{cr,N}$ [mm]	45	60	90	45	60	105	60	75	120

Anchor size		M12			M16			M20		
Nominal anchorage depth	h_{nom} [mm]	64	79	114	77	92	132	90	115	130
Effective anchorage depth	h_{ef} [mm]	50	65	100	65	80	120	75	100	115
Critical spacing for splitting failure	$s_{cr,sp}$ [mm]	200	250	310	230	280	380	260	370	400
Critical edge distance for splitting failure	$c_{cr,sp}$ [mm]	100	125	155	115	140	190	130	185	200
Critical spacing for concrete cone failure	$s_{cr,N}$ [mm]	150	195	300	195	240	360	225	300	345
Critical edge distance for concrete cone failure	$c_{cr,N}$ [mm]	75	97,5	150	97,5	120	180	112,5	150	172,5

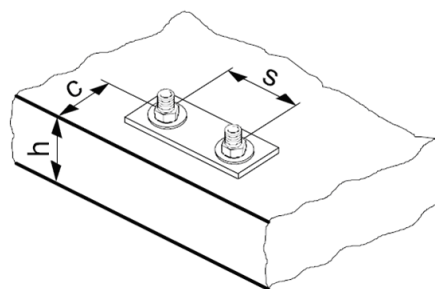

For spacing (edge distance) smaller than critical spacing (critical edge distance) the design loads have to be reduced.

Simplified design method

Simplified version of the design method according ETAG 001, Annex C. Design resistance according ETA-11/0374, issue 2012-07-19.

- Influence of concrete strength
- Influence of edge distance
- Influence of spacing
- Valid for a group of two anchors. (The method may also be applied for anchor groups with more than two anchors or more than one edge. The influencing factors must then be considered for each edge distance and spacing. The calculated design loads are then conservative: They will be lower than the exact values according ETAG 001, Annex C. To avoid this, it is recommended to use the anchor design software PROFIS anchor)

The design method is based on the following simplification:

- No different loads are acting on individual anchors (no eccentricity)

The values are valid for one anchor.

For more complex fastening applications please use the anchor design software PROFIS Anchor.

Tension loading

The design tensile resistance is the lower value of

- Steel resistance: $N_{Rd,s}$
- Concrete pull-out resistance: $N_{Rd,p} = N_{Rd,p}^0 \cdot f_B$
- Concrete cone resistance: $N_{Rd,c} = N_{Rd,c}^0 \cdot f_B \cdot f_{1,N} \cdot f_{2,N} \cdot f_{3,N} \cdot f_{re,N}$
- Concrete splitting resistance (only non-cracked concrete):
 $N_{Rd,sp} = N_{Rd,c}^0 \cdot f_B \cdot f_{1,sp} \cdot f_{2,sp} \cdot f_{3,sp} \cdot f_{h,sp} \cdot f_{re,N}$

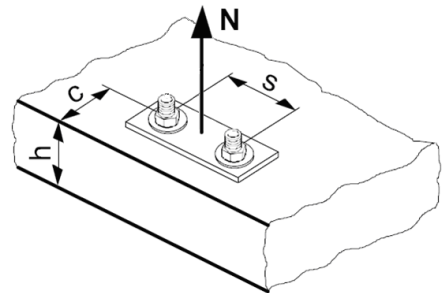

Basic design tensile resistance

Design steel resistance $N_{Rd,s}$

Anchor size		M6	M8	M10	M12	M16	M20
$N_{Rd,s}$	HSA, HSA-BW [kN]	6,4	11,8	20,0	29,6	59,0	88,5
	HSA-R2, HSA-R [kN]	8,7	13,1	25,0	31,9	62,6	68,5

Design pull-out resistance $N_{Rd,p} = N_{Rd,p}^0 \cdot f_B$

Anchor size			M6			M8			M10		
Effective anchorage depth	h_{ef}	[mm]	30	40	60	30	40	70	40	50	80
$N_{Rd,p}^0$	HSA, HSA-BW, HSA-R2, HSA-R	[kN]	4,0	5,0	6,0	No pull-out		10,7	No pull-out		16,7

Anchor size			M12			M16			M20		
Effective anchorage depth	h_{ef}	[mm]	50	65	100	65	80	120	75	100	115
$N_{Rd,p}^0$	HSA, HSA-BW, HSA-R2, HSA-R	[kN]	No pull-out		23,3	No pull-out		33,3	No pull-out		

Design concrete cone resistance $N_{Rd,c} = N_{Rd,c}^0 \cdot f_B \cdot f_{1,N} \cdot f_{2,N} \cdot f_{3,N} \cdot f_{re,N}$

Design splitting resistance $N_{Rd,sp} = N_{Rd,c}^0 \cdot f_B \cdot f_{1,sp} \cdot f_{2,sp} \cdot f_{3,sp} \cdot f_{h,sp} \cdot f_{re,N}$

Anchor size			M6			M8			M10		
Effective anchorage depth	h_{ef}	[mm]	30	40	60	30	40	70	40	50	80
$N_{Rd,p}^0$	HSA, HSA-BW, HSA-R2, HSA-R	[kN]	5,5	8,5	15,6	5,5	8,5	19,7	8,5	11,9	24,1

Anchor size			M12			M16			M20		
Effective anchorage depth	h_{ef}	[mm]	50	65	100	65	80	120	75	100	115
$N_{Rd,p}^0$	HSA, HSA-BW, HSA-R2, HSA-R	[kN]	11,9	17,6	33,7	17,6	24,1	44,3	21,9	33,7	41,5

Influencing factors

Influence of concrete strength

Concrete strength designation (ENV 206)	C 20/25	C 25/30	C 30/37	C 35/45	C 40/50	C 45/55	C 50/60
Pull-out, concrete cone and splitting resistance							
$f_B = (f_{ck,cube}/25N/mm^2)^{1/2}$ a)	1	1,1	1,22	1,34	1,41	1,48	1,55

a) $f_{ck,cube}$ = concrete compressive strength, measured on cubes with 150 mm side length

Influence of edge distance a)

$c/c_{cr,N}$	0,1	0,2	0,3	0,4	0,5	0,6	0,7	0,8	0,9	1
$c/c_{cr,sp}$										
$f_{1,N} = 0,7 + 0,3 \cdot c/c_{cr,N} \leq 1$	0,73	0,76	0,79	0,82	0,85	0,88	0,91	0,94	0,97	1
$f_{1,sp} = 0,7 + 0,3 \cdot c/c_{cr,sp} \leq 1$										
$f_{2,N} = 0,5 \cdot (1 + c/c_{cr,N}) \leq 1$	0,55	0,60	0,65	0,70	0,75	0,80	0,85	0,90	0,95	1
$f_{2,sp} = 0,5 \cdot (1 + c/c_{cr,sp}) \leq 1$										

a) The edge distance shall not be smaller than the minimum edge distance c_{min} given in the table with the setting details. These influencing factors must be considered for every edge distance.

Influence of anchor spacing ^{a)}

$s/s_{cr,N}$	0,1	0,2	0,3	0,4	0,5	0,6	0,7	0,8	0,9	1
$s/s_{cr,sp}$										
$f_{3,N} = 0,5 \cdot (1 + s/s_{cr,N}) \leq 1$										
$f_{3,sp} = 0,5 \cdot (1 + s/s_{cr,sp}) \leq 1$	0,55	0,60	0,65	0,70	0,75	0,80	0,85	0,90	0,95	1

a) The anchor spacing shall not be smaller than the minimum anchor spacing s_{min} given in the table with the setting details. This influencing factor must be considered for every anchor spacing.

Influence of base material thickness

h/h_{min}	1,0	1,1	1,2	1,3	1,4	1,5	1,6	1,7	1,8	$\geq 1,84$
$f_{h,sp} = [h/(h_{min})]^{2/3}$	1	1,07	1,13	1,19	1,25	1,31	1,37	1,42	1,48	1,5

Influence of reinforcement ^{a)}

Anchor size	M6			M8			M10		
Effective anchorage depth h_{ef} [mm]	30	40	60	30	40	70	40	50	80
$f_{re,N} = 0,5 + h_{ef}/200mm \leq 1$	0,65	0,7	0,8	0,65	0,7	0,85	0,7	0,75	0,9

Anchor size	M12			M16			M20		
Effective anchorage depth h_{ef} [mm]	50	65	100	65	80	120	75	100	115
$f_{re,N} = 0,5 + h_{ef}/200mm \leq 1$	0,75	0,83	1	0,83	0,9	1	0,88	1	1

a) This factor applies only for dense reinforcement. If in the area of anchorage there is reinforcement with a spacing ≥ 150 mm (any diameter) or with a diameter ≤ 10 mm and a spacing ≥ 100 mm, then a factor $f_{re,N} = 1$ may be applied.

Shear loading

The design shear resistance is the lower value of

- Steel resistance: $V_{Rd,s}$
- Concrete pryout resistance: $V_{Rd,cp} = k \cdot N_{Rd,c}$
- Concrete edge resistance: $V_{Rd,c} = V_{Rd,c}^0 \cdot f_B \cdot f_{\beta} \cdot f_h \cdot f_4 \cdot f_{hef} \cdot f_c$

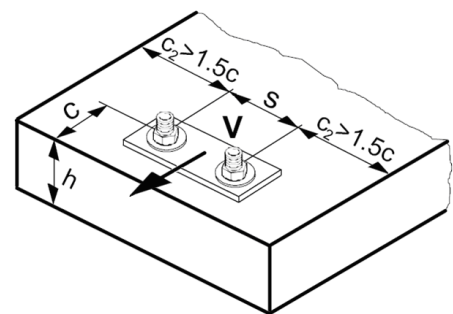

Basic design shear resistance

Design steel resistance $V_{Rd,s}$

Anchor size		M6	M8	M10	M12	M16	M20
$V_{Rd,s}$	HSA, HSA-BW [kN]	5,2	8,5	15,1	23,6	40,8	68,6
	HSA-R2, HSA-R [kN]	5,8	9,8	18,1	23,4	45,2	73,5

Design concrete pryout resistance $V_{Rd,cp} = k \cdot N_{Rd,c}$ ^{a)}

Anchor size			M6			M8			M10		
Effective anchorage depth	h_{ef}	[mm]	30	40	60	30	40	70	40	50	80
k			1	1	2	1	1,5	2	2,4	2,4	2,4

Anchor size			M12			M16			M20		
Effective anchorage depth	h_{ef}	[mm]	50	65	100	65	80	120	75	100	115
k			2	2	2	2,9	2,9	2,9	2	3,5	3,5

a) $N_{Rd,c}$: Design concrete cone resistance

Design concrete edge resistance $V_{Rd,c}^0 = V_{Rd,c}^0 \cdot f_B \cdot f_{\beta} \cdot f_h \cdot f_4 \cdot f_{hef} \cdot f_c$

Anchor size			M6			M8			M10		
Effective anchorage depth	h_{ef}	[mm]	30	40	60	30	40	70	40	50	80
$V_{Rd,c}^0$ [kN]			3,6	3,6	3,7	5,8	5,9	6,0	8,5	8,5	8,6

Anchor size			M12			M16			M20		
Effective anchorage depth	h_{ef}	[mm]	50	65	100	65	80	120	75	100	115
$V_{Rd,c}^0$ [kN]			11,6	11,6	11,7	18,7	18,8	18,9	27,2	27,3	27,4

a) For anchor groups only the anchors close to the edge must be considered.

Influencing factors

Influence of concrete strength

Concrete strength designation (ENV 206)	C 20/25	C 25/30	C 30/37	C 35/45	C 40/50	C 45/55	C 50/60
$f_B = (f_{ck,cube}/25N/mm^2)^{1/2}$ ^{a)}	1	1,1	1,22	1,34	1,41	1,48	1,55

a) $f_{ck,cube}$ = concrete compressive strength, measured on cubes with 150 mm side length

Influence of angle between load applied and the direction perpendicular to the free edge

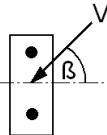
Angle β	0°	10°	20°	30°	40°	50°	60°	70°	80°	≥ 90°
$f_{\beta} = \frac{1}{\sqrt{(\cos \alpha_v)^2 + \left(\frac{\sin \alpha_v}{2,5}\right)^2}}$ 	1	1,01	1,05	1,13	1,24	1,40	1,64	1,97	2,32	2,50

Influence of base material thickness

h/c	0,15	0,3	0,45	0,6	0,75	0,9	1,05	1,2	1,35	≥ 1,5
$f_h = \{h/(1,5 \cdot c)\}^{1/2} \leq 1$	0,32	0,45	0,55	0,63	0,71	0,77	0,84	0,89	0,95	1,00

Influence of anchor spacing and edge distance ^{a)} for concrete edge resistance: f_4

$$f_4 = (c/h_{ef})^{1,5} \cdot (1 + s / [3 \cdot c]) \cdot 0,5$$

c/h _{ef}	Single anchor	Group of two anchors s/h _{ef}														
		0,75	1,50	2,25	3,00	3,75	4,50	5,25	6,00	6,75	7,50	8,25	9,00	9,75	10,50	11,25
0,50	0,35	0,27	0,35	0,35	0,35	0,35	0,35	0,35	0,35	0,35	0,35	0,35	0,35	0,35	0,35	0,35
0,75	0,65	0,43	0,54	0,65	0,65	0,65	0,65	0,65	0,65	0,65	0,65	0,65	0,65	0,65	0,65	0,65
1,00	1,00	0,63	0,75	0,88	1,00	1,00	1,00	1,00	1,00	1,00	1,00	1,00	1,00	1,00	1,00	1,00
1,25	1,40	0,84	0,98	1,12	1,26	1,40	1,40	1,40	1,40	1,40	1,40	1,40	1,40	1,40	1,40	1,40
1,50	1,84	1,07	1,22	1,38	1,53	1,68	1,84	1,84	1,84	1,84	1,84	1,84	1,84	1,84	1,84	1,84
1,75	2,32	1,32	1,49	1,65	1,82	1,98	2,15	2,32	2,32	2,32	2,32	2,32	2,32	2,32	2,32	2,32
2,00	2,83	1,59	1,77	1,94	2,12	2,30	2,47	2,65	2,83	2,83	2,83	2,83	2,83	2,83	2,83	2,83
2,25	3,38	1,88	2,06	2,25	2,44	2,63	2,81	3,00	3,19	3,38	3,38	3,38	3,38	3,38	3,38	3,38
2,50	3,95	2,17	2,37	2,57	2,77	2,96	3,16	3,36	3,56	3,76	3,95	3,95	3,95	3,95	3,95	3,95
2,75	4,56	2,49	2,69	2,90	3,11	3,32	3,52	3,73	3,94	4,15	4,35	4,56	4,56	4,56	4,56	4,56
3,00	5,20	2,81	3,03	3,25	3,46	3,68	3,90	4,11	4,33	4,55	4,76	4,98	5,20	5,20	5,20	5,20
3,25	5,86	3,15	3,38	3,61	3,83	4,06	4,28	4,51	4,73	4,96	5,18	5,41	5,63	5,86	5,86	5,86
3,50	6,55	3,51	3,74	3,98	4,21	4,44	4,68	4,91	5,14	5,38	5,61	5,85	6,08	6,31	6,55	6,55
3,75	7,26	3,87	4,12	4,36	4,60	4,84	5,08	5,33	5,57	5,81	6,05	6,29	6,54	6,78	7,02	7,26
4,00	8,00	4,25	4,50	4,75	5,00	5,25	5,50	5,75	6,00	6,25	6,50	6,75	7,00	7,25	7,50	7,75
4,25	8,76	4,64	4,90	5,15	5,41	5,67	5,93	6,18	6,44	6,70	6,96	7,22	7,47	7,73	7,99	8,25
4,50	9,55	5,04	5,30	5,57	5,83	6,10	6,36	6,63	6,89	7,16	7,42	7,69	7,95	8,22	8,49	8,75
4,75	10,35	5,45	5,72	5,99	6,27	6,54	6,81	7,08	7,36	7,63	7,90	8,17	8,45	8,72	8,99	9,26
5,00	11,18	5,87	6,15	6,43	6,71	6,99	7,27	7,55	7,83	8,11	8,39	8,66	8,94	9,22	9,50	9,78
5,25	12,03	6,30	6,59	6,87	7,16	7,45	7,73	8,02	8,31	8,59	8,88	9,17	9,45	9,74	10,02	10,31
5,50	12,90	6,74	7,04	7,33	7,62	7,92	8,21	8,50	8,79	9,09	9,38	9,67	9,97	10,26	10,55	10,85

- a) The anchor spacing and the edge distance shall not be smaller than the minimum anchor spacing s_{min} and the minimum edge distance c_{min} .

Influence of embedment depth

Anchor size	M6			M8			M10		
Effective anchorage depth h_{ef} [mm]	30	40	60	30	40	70	40	50	80
$f_{hef} = 0,05 \cdot (h_{ef} / d)^{1,68}$	0,75	1,21	2,39	0,46	0,75	1,91	0,51	0,75	1,64

Anchor size	M12			M16			M20		
Effective anchorage depth h_{ef} [mm]	50	65	100	65	80	120	75	100	115
$f_{hef} = 0,05 \cdot (h_{ef} / d)^{1,68}$	0,55	0,85	1,76	0,53	0,75	1,48	0,46	0,75	0,94

Influence of edge distance ^{a)}

c/d	4	6	8	10	15	20	30	40
$f_c = (d / c)^{0,19}$	0,77	0,71	0,67	0,65	0,60	0,57	0,52	0,50

- a) The edge distance shall not be smaller than the minimum edge distance c_{min} .

Combined tension and shear loading

For combined tension and shear loading see section "Anchor Design".

Precalculated values

Design resistance calculated according ETAG 001, Annex C and Hilti technical data.
All data applies to concrete C 20/25 – $f_{ck,cube} = 25 \text{ N/mm}^2$.

Recommended loads can be calculated by dividing the design resistance by an overall partial safety factor for action $\gamma = 1,4$. The partial safety factors for action depend on the type of loading and shall be taken from national regulations.

Design resistance

Single anchor, no edge effects

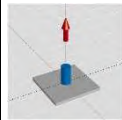
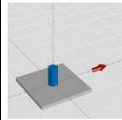
Anchor size		M6			M8			M10			
Effective anchorage depth	h_{ef} [mm]	30	40	60	30	40	70	40	50	80	
Min. base material thickness h_{min} [mm]		100	100	120	100	100	120	100	120	160	
	Tensile N_{Rd}										
	HSA, HSA-BW	[kN]	4,0	5,0	6,0	5,5	8,5	10,7	8,5	11,9	16,7
	HSA-R2, HSA-R	[kN]	4,0	5,0	6,0	5,5	8,5	10,7	8,5	11,9	16,7
	Shear V_{Rd}, without lever arm										
	HSA, HSA-BW	[kN]	5,2	5,2	5,2	5,5	8,5	8,5	15,1	15,1	15,1
	HSA-R2, HSA-R	[kN]	5,5	5,8	5,8	5,5	9,8	9,8	18,1	18,1	18,1

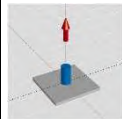
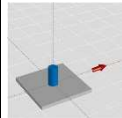
Anchor size		M12			M16			M20			
Effective anchorage depth	h_{ef} [mm]	50	65	100	65	80	120	75	100	115	
Min. base material thickness h_{min} [mm]		100	140	180	140	160	180	160	220	220	
	Tensile N_{Rd}										
	HSA, HSA-BW	[kN]	11,9	17,6	23,3	17,6	24,1	33,3	21,9	33,7	41,5
	HSA-R2, HSA-R	[kN]	11,9	17,6	23,3	17,6	24,1	33,3	21,9	33,7	41,5
	Shear V_{Rd}, without lever arm										
	HSA, HSA-BW	[kN]	23,6	23,6	23,6	40,8	40,8	40,8	43,7	68,6	68,6
	HSA-R2, HSA-R	[kN]	23,4	23,4	23,4	45,2	45,2	45,2	43,7	73,5	73,5

Single anchor, min. edge distance ($c = c_{min}$)

Anchor size		M6			M8			M10			
Effective anchorage depth	h_{ef} [mm]	30	40	60	30	40	70	40	50	80	
Min. base material thickness	h_{min} [mm]	100	100	120	100	100	120	100	120	160	
Min. edge distance	c_{min} [mm]	35	35	35	40	35	35	50	40	40	
	Tensile N_{Rd}										
	HSA, HSA-BW	[kN]	4,0	5,0	6,0	4,0	4,8	10,5	5,6	6,7	12,0
	HSA-R2, HSA-R	[kN]	4,0	5,0	6,0	4,0	4,8	10,5	5,6	6,7	12,0
	Shear V_{Rd}, without lever arm										
	HSA, HSA-BW	[kN]	2,5	2,6	2,8	3,1	2,7	3,0	4,5	3,5	3,9
	HSA-R2, HSA-R	[kN]	2,5	2,6	2,8	3,1	2,7	3,0	4,5	3,5	3,9

Anchor size		M12			M16			M20			
Effective anchorage depth	h_{ef} [mm]	50	65	100	65	80	120	75	100	115	
Min. base material thickness	h_{min} [mm]	100	140	180	140	160	180	160	220	220	
Min. edge distance	c_{min} [mm]	70	65	55	80	75	70	130	120	120	
	Tensile N_{Rd}										
	HSA, HSA-BW	[kN]	9,2	11,5	18,4	13,6	15,9	24,5	21,9	24,8	29,2
	HSA-R2, HSA-R	[kN]	9,2	11,5	18,4	13,6	15,9	24,5	21,9	24,8	29,2
	Shear V_{Rd}, without lever arm										
	HSA, HSA-BW	[kN]	7,4	7,2	6,4	9,9	9,5	9,6	18,1	19,1	19,6
	HSA-R2, HSA-R	[kN]	7,4	7,2	6,4	9,9	9,5	9,6	18,1	19,1	19,6

Double anchor, no edge effects, min. spacing ($s = s_{min}$),
(load values are valid for one anchor)

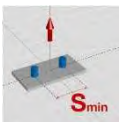
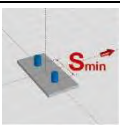
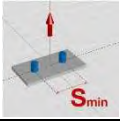
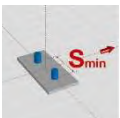
Anchor size		M6			M8			M10			
Effective anchorage depth	h_{ef} [mm]	30	40	60	30	40	70	40	50	80	
Min. base material thickness	h_{min} [mm]	100	100	120	100	100	120	100	120	160	
Min. spacing	s_{min} [mm]	35	35	35	35	35	35	50	50	50	
	Tensile N_{Rd}										
	HSA, HSA-BW	[kN]	3,7	5,0	6,0	3,5	5,1	10,7	5,4	7,4	14,1
	HSA-R2, HSA-R	[kN]	3,7	5,0	6,0	3,5	5,1	10,7	5,4	7,4	14,1
	Shear V_{Rd}, without lever arm										
	HSA, HSA-BW	[kN]	3,8	5,2	5,2	3,8	8,3	8,5	14,5	15,1	15,1
	HSA-R2, HSA-R	[kN]	3,8	5,5	5,8	3,8	8,3	9,8	14,5	18,1	18,1
Anchor size		M12			M16			M20			
Effective anchorage depth	h_{ef} [mm]	50	65	100	65	80	120	75	100	115	
Min. base material thickness	h_{min} [mm]	100	140	180	140	160	180	160	220	220	
Min. spacing	s_{min} [mm]	70	70	70	90	90	90	195	175	175	
	Tensile N_{Rd}										
	HSA, HSA-BW	[kN]	8,0	11,3	20,6	12,3	15,9	27,4	19,1	24,8	29,8
	HSA-R2, HSA-R	[kN]	8,0	11,3	20,6	12,3	15,9	27,4	19,1	24,8	29,8
	Shear V_{Rd}, without lever arm										
	HSA, HSA-BW	[kN]	17,5	23,6	23,6	37,4	40,8	40,8	40,8	68,6	68,6
	HSA-R2, HSA-R	[kN]	17,5	23,4	23,4	37,4	45,2	45,2	40,8	73,5	73,5

HSA-F Stud anchor

	Anchor version	Benefits
	HSA-F; Carbon steel, hot dipped galvanized, min 35 microns coating thickness DIN 125 washer	<ul style="list-style-type: none"> - Hot dipped galvanized material for increased corrosion resistance - Three embedment depths for maximal design flexibility - Suitable for pre- and through fastening

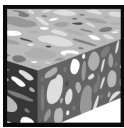

Concrete

Basic loading data (for a single anchor)

All data in this section applies to

- Correct setting (See setting instruction)
- No edge distance and spacing influence
- Steel failure
- Minimum base material thickness
- Non-cracked Concrete C 20/25, $f_{ck,cube} = 25 \text{ N/mm}^2$

For details see Simplified design method

Mean ultimate resistance

Anchor size			M6			M8			M10		
Effective anchorage depth	h_{ef}	[mm]	30	40		30	40	70	40	50	80
Tensile	$N_{R,u,m}$	[kN]	8,0	9,5		11,0	17,0	17,3	17,0	21,2	26,6
Shear	$V_{R,u,m}$	[kN]	6,8	6,8		11,0	11,1	11,1	19,8	19,8	19,8

Anchor size			M12			M16			M20		
Effective anchorage depth	h_{ef}	[mm]	50	65	100	65	80	120	75	100	115
Tensile	$N_{R,u,m}$	[kN]	23,7	33,2	33,2	26,6	39,8	53,1	43,5	67,0	82,7
Shear	$V_{R,u,m}$	[kN]	31,0	31,0	31,0	53,6	53,6	53,6	87,1	90,1	90,1

Characteristic resistance

Anchor size			M6			M8			M10		
Effective anchorage depth	h_{ef}	[mm]	30	40		30	40	70	40	50	80
Tensile	N_{Rk}	[kN]	6,0	7,5		8,3	12,8	16,0	12,8	16,0	20,0
Shear	V_{Rk}	[kN]	6,5	6,5		8,3	10,6	10,6	18,9	18,9	18,9

Anchor size			M12			M16			M20		
Effective anchorage depth	h_{ef}	[mm]	50	65	100	65	80	120	75	100	115
Tensile	N_{Rk}	[kN]	17,9	25,0	25,0	20,0	30,0	40,0	32,8	50,5	62,3
Shear	V_{Rk}	[kN]	29,5	29,5	29,5	51,0	51,0	51,0	65,6	85,8	85,8

Design resistance

Anchor size			M6			M8			M10		
Effective anchorage depth	h_{ef}	[mm]	30	40		30	40	70	40	50	80
Tensile	N_{Rd}	[kN]	4,0	5,0		5,5	8,5	10,7	8,5	10,7	13,3
Shear	V_{Rd}	[kN]	5,2	5,2		5,5	8,5	8,5	15,1	15,1	15,1

Anchor size			M12			M16			M20		
Effective anchorage depth	h_{ef}	[mm]	50	65	100	65	80	120	75	100	115
Tensile	N_{Rd}	[kN]	11,9	16,7	16,7	13,3	20,0	26,7	21,9	33,7	41,5
Shear	V_{Rd}	[kN]	23,6	23,6	23,6	40,8	40,8	40,8	43,7	68,6	68,6

Recommended loads

Anchor size			M6			M8			M10		
Effective anchorage depth	h_{ef}	[mm]	30	40		30	40	70	40	50	80
Tensile	N_{rec}	[kN]	2,9	3,6		4,0	6,1	7,6	6,1	7,6	9,5
Shear	V_{rec}	[kN]	3,7	3,7		4,0	6,1	6,1	10,8	10,8	10,8

Anchor size			M12			M16			M20		
Effective anchorage depth	h_{ef}	[mm]	50	65	100	65	80	120	75	100	115
Tensile	N_{rec}	[kN]	8,5	11,9	11,9	9,5	14,3	19,0	15,6	24,0	29,7
Shear	V_{rec}	[kN]	16,9	16,9	16,9	29,1	29,1	29,1	31,2	49,0	49,0

Materials

Mechanical properties

Anchor size		M6	M8	M10	M12	M16	M20
Nominal tensile strength $f_{uk,thread}$	[N/mm ²]	650	580	650	700	650	700
Yield strength $f_{yk,thread}$	[N/mm ²]	520	464	520	560	520	560
Stressed cross-section $A_{s,thread}$	[mm ²]	20,1	36,6	58,0	84,3	157,0	245,0
Moment of resistance W	[mm ³]	12,7	31,2	62,3	109,2	277,5	540,9
Char. bending resistance $M_{Rk,s}^0$	[Nm]	9,9	21,7	48,6	91,7	216,4	454,4

Material quality

Type	Part	Material	Coating
HSA-F Carbon Steel	Sleeve	Stainless steel A2 1.4301	-
	Bolt	Carbon steel, Rupture elongation $A_5 > 8\%$	Hot dipped galvanized ($\geq 35 \mu\text{m}$)
	Washer	HSA :carbon steel	
	Hexagon nut	Steel, strength class 8	

Geometry washer

Anchor Size		M6	M8	M10	M12	M16	M20
Inner diameter d_1							
HSA-F	d_1 [mm]	6,4	8,4	10,5	13,0	17,0	21
Outer diameter d_2							
HSA-F	d_2 [mm]	12,0	16,0	20,0	24,0	30,0	37,0
Thickness h							
HSA-F	h [mm]	1,6	1,6	2,0	2,5	3,0	3,0

Anchor dimensions and coding

Product marking and identification of anchor

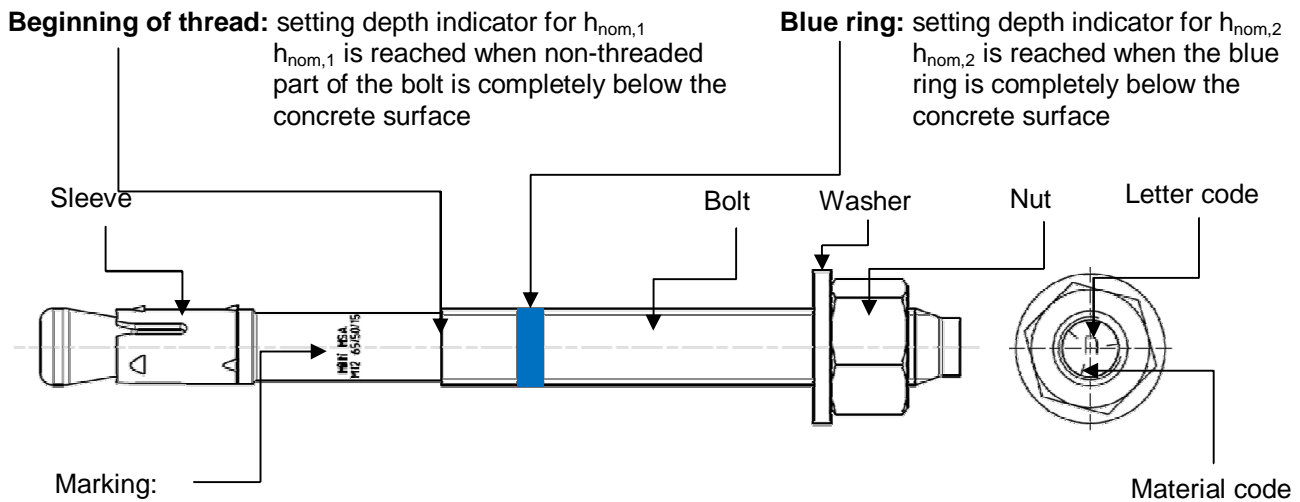

e.g.

Hilti HSA-F ... Brand and Anchor type

M12 65/50/15 ... Anchor Size and the max. $t_{fix,1}/t_{fix,2}/t_{fix,3}$ for the corresponding $h_{nom,1}/h_{nom,2}/h_{nom,3}$

Material code for identification of different materials

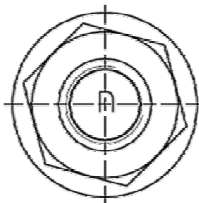
Type	HSA-F (carbon steel, hot dipped galvanized)
Material Code	 <p>Letter code without mark</p>

Effective and nominal anchorage depth

Anchor size			M6		M8			M10		
Effective anchorage depth	h_{ef}	[mm]	30	40	30	40	70	40	50	80
Nominal anchorage depth	h_{nom}	[mm]	37	47	39	49	79	50	60	90

Anchor size			M12			M16			M20		
Effective anchorage depth	h_{ef}	[mm]	50	65	100	65	80	120	75	100	115
Nominal anchorage depth	h_{nom}	[mm]	64	79	114	77	92	132	90	115	130

Letter code for anchor length and maximum thickness of the fixture t_{fix}

Type	HSA-F					
Size	M6	M8	M10	M12	M16	M20
h_{nom} [mm]	37 / 47 / -	39 / 49 / 79	50 / 60 / 90	64 / 79 / 114	77 / 92 / 132	90 / 115 / 130
Letter t_{fix}	$t_{fix,1}/t_{fix,2}/t_{fix,3}$	$t_{fix,1}/t_{fix,2}/t_{fix,3}$	$t_{fix,1}/t_{fix,2}/t_{fix,3}$	$t_{fix,1}/t_{fix,2}/t_{fix,3}$	$t_{fix,1}/t_{fix,2}/t_{fix,3}$	$t_{fix,1}/t_{fix,2}/t_{fix,3}$
z	5/-/-	5/-/-	5/-/-	5/ -/-	5/-/-	
y						10/-/-
w	20/10/-	20/10/-	20/10/-	20/5/-		
t		35/25/-	35/25/-	35/20/-		
s					40/25/-	
g			50/40/10			
p		55/45/15				55/30/15
n				65/50/15		
k		80/70/40				
j					85/70/30	
a				145/130/95		

Setting

Installation equipment

Anchor size	M6	M8	M10	M12	M16	M20
Rotary hammer	TE2 – TE16					TE40 – TE70
Other tools	hammer, torque wrench, blow out pump					

Setting instruction

Drill and clean borehole

Standard drilling method

M6 – M20: Hammer drilling (HD)

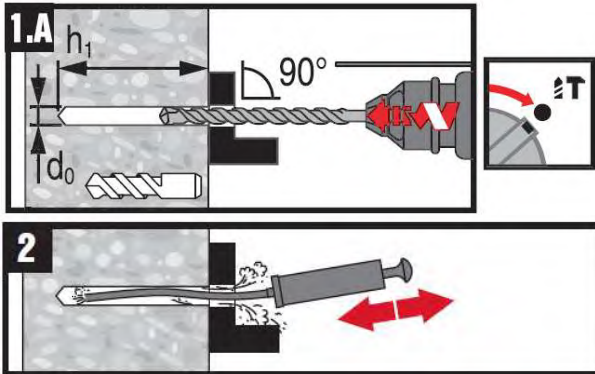

Install anchor with hammer or machine setting tool

Standard setting method

M6 – M20: Hammer setting

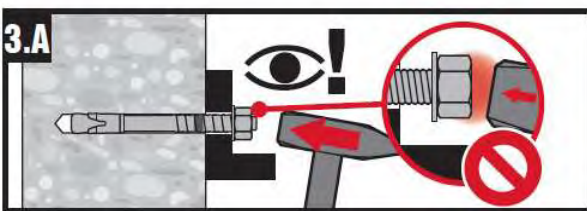

Alternative setting method

M8 – M16: Machine setting

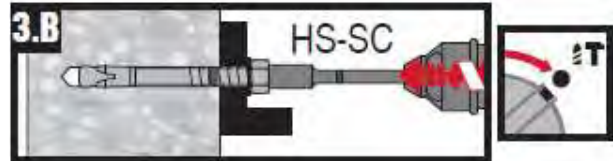

Check setting

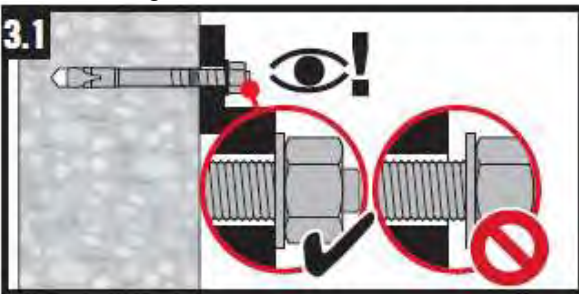

Tightening the anchor

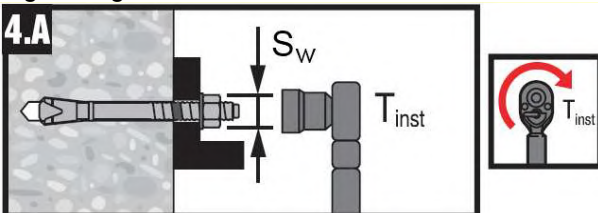

For detailed information on installation see instruction for use given with the package of the product.

Setting details

One anchor length for different fixture thickness t_{fix} and the corresponding setting positions

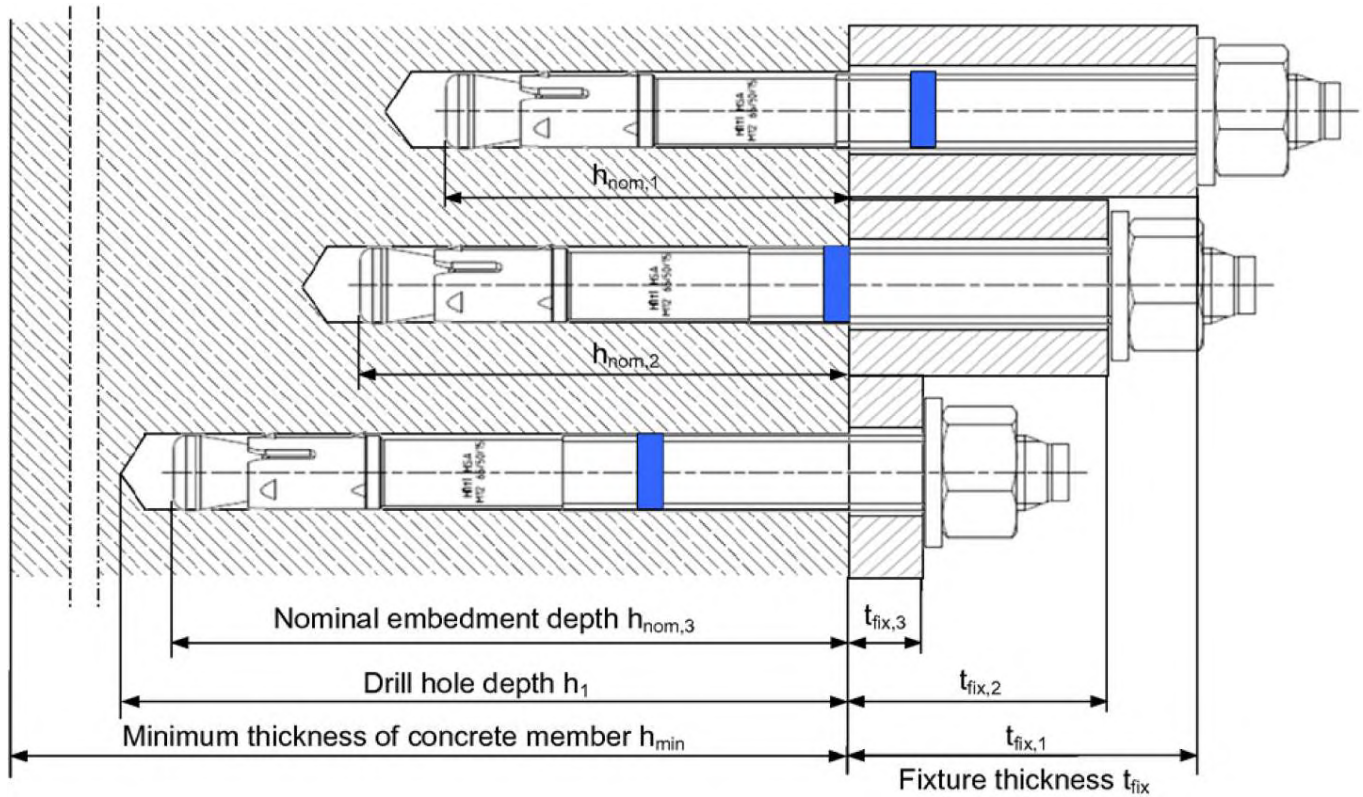

Different anchor length for different setting positions and the corresponding fixture thickness t_{fix}

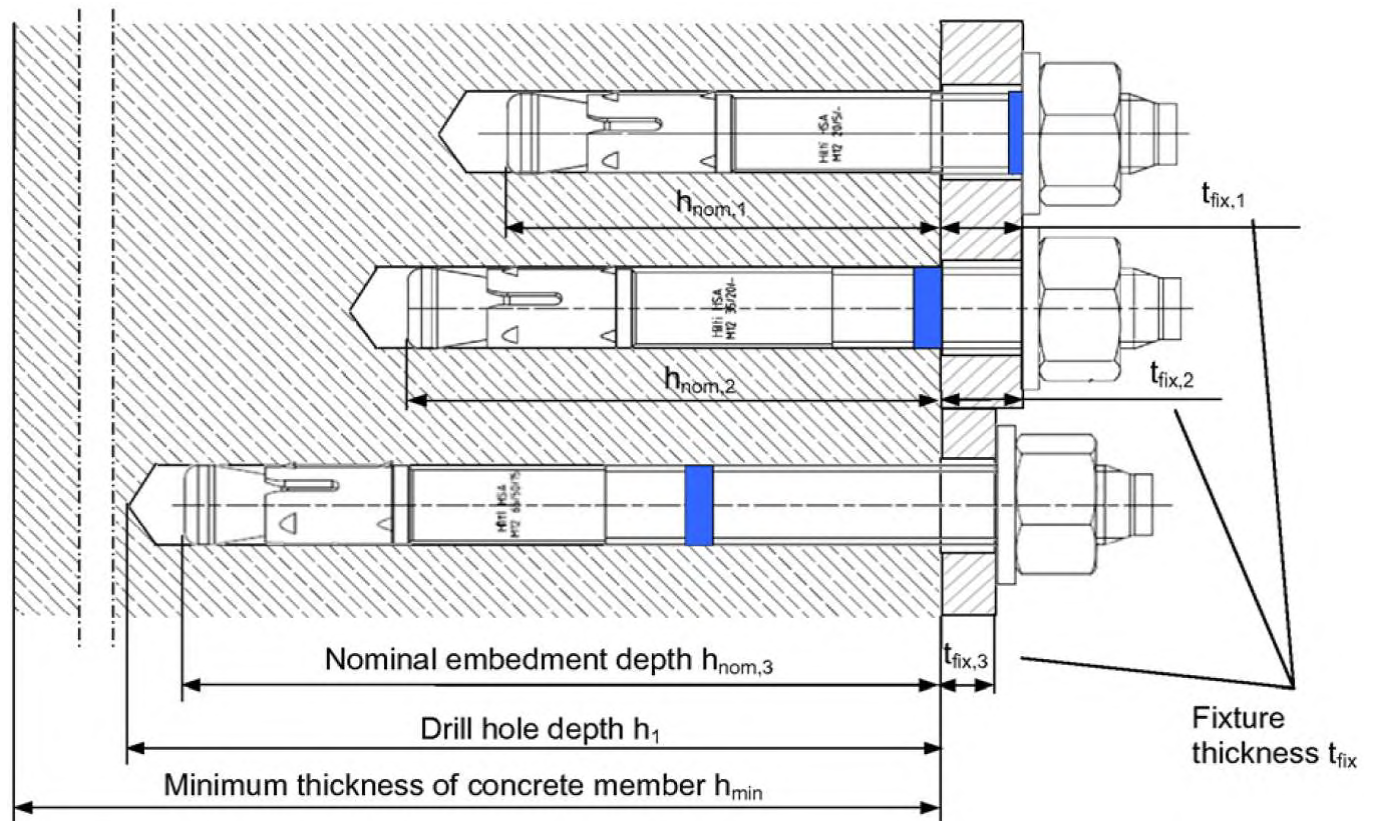

Setting details

Anchor size		M6		M8			M10		
Nominal anchorage depth	h_{nom} [mm]	37	47	39	49	79	50	60	90
Minimum base material thickness	h_{min} [mm]	100	100	100	100	120	100	120	160
Minimum spacing	s_{min} [mm]	35	35	85	85	85	100	100	100
Minimum edge distance	c_{min} [mm]	35	35	75	75	60	60	60	55
Nominal diameter of drill bit	d_o [mm]	6		8			10		
Cutting diameter of drill bit	$d_{cut} \leq$ [mm]	6,4		8,45			10,45		
Depth of drill hole	$h_1 \geq$ [mm]	42	52	44	54	84	55	65	95
Diameter of clearance hole in the fixture	$d_f \leq$ [mm]	7		9			12		
Torque moment	T_{inst} [Nm]	5		15			25		
Width across	SW [mm]	10		13			17		

Anchor size		M12			M16			M20		
Nominal anchorage depth	h_{nom} [mm]	64	79	114	77	92	132	90	115	130
Minimum base material thickness	h_{min} [mm]	100	140	180	140	160	180	160	220	220
Minimum spacing	s_{min} [mm]	100	100	100	190	190	190	200	200	200
Minimum edge distance	c_{min} [mm]	175	140	90	170	140	120	185	165	165
Nominal diameter of drill bit	d_o [mm]	12			16			20		
Cutting diameter of drill bit	$d_{cut} \leq$ [mm]	12,5			16,5			20,55		
Depth of drill hole	$h_1 \geq$ [mm]	72	87	122	85	100	140	98	123	138
Diameter of clearance hole in the fixture	$d_f \leq$ [mm]	14			18			22		
Torque moment	T_{inst} [Nm]	50			80			200		
Width across	SW [mm]	19			24			30		

Design parameters

Anchor size		M6		M8			M10		
Nominal anchorage depth	h_{nom} [mm]	37	47	39	49	79	50	60	90
Effective anchorage depth	h_{ef} [mm]	30	40	30	40	70	40	50	80
Critical spacing for splitting failure	$s_{cr,sp}$ [mm]	126	150	162	226	250	238	262	362
Critical edge distance for splitting failure	$c_{cr,sp}$ [mm]	63	75	81	113	125	119	131	181
Critical spacing for concrete cone failure	$s_{cr,N}$ [mm]	90	120	90	120	210	120	150	240
Critical edge distance for concrete cone failure	$c_{cr,N}$ [mm]	45	60	45	60	105	60	75	120

Anchor size		M12			M16			M20		
Nominal anchorage depth	h_{nom} [mm]	64	79	114	77	92	132	90	115	130
Effective anchorage depth	h_{ef} [mm]	50	65	100	65	80	120	75	100	115
Critical spacing for splitting failure	$s_{cr,sp}$ [mm]	250	312	388	288	350	476	326	462	500
Critical edge distance for splitting failure	$c_{cr,sp}$ [mm]	125	156	194	144	175	238	163	231	250
Critical spacing for concrete cone failure	$s_{cr,N}$ [mm]	150	195	300	195	240	360	225	300	345
Critical edge distance for concrete cone failure	$c_{cr,N}$ [mm]	75	97,5	150	97,5	120	180	112,5	150	172,5

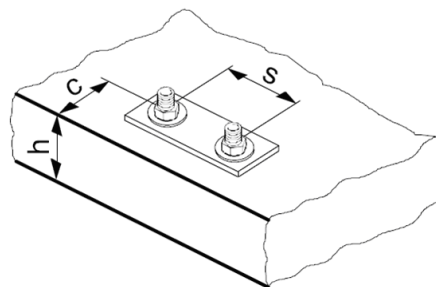

For spacing (edge distance) smaller than critical spacing (critical edge distance) the design loads have to be reduced.

Simplified design method

Simplified version of the design method according ETAG 001, Annex C. Design resistance according Hilti technical data.

- Influence of concrete strength
- Influence of edge distance
- Influence of spacing
- Valid for a group of two anchors. (The method may also be applied for anchor groups with more than two anchors or more than one edge. The influencing factors must then be considered for each edge distance and spacing. The calculated design loads are then conservative: They will be lower than the exact values according ETAG 001, Annex C. To avoid this, it is recommended to use the anchor design software PROFIS anchor)

The design method is based on the following simplification:

- No different loads are acting on individual anchors (no eccentricity)

The values are valid for one anchor.

For more complex fastening applications please use the anchor design software PROFIS Anchor.

Tension loading

The design tensile resistance is the lower value of

- Steel resistance: $N_{Rd,s}$
- Concrete pull-out resistance: $N_{Rd,p} = N_{Rd,p}^0$
- Concrete cone resistance: $N_{Rd,c} = N_{Rd,c}^0 \cdot f_B \cdot f_{1,N} \cdot f_{2,N} \cdot f_{3,N} \cdot f_{re,N}$
- Concrete splitting resistance: $N_{Rd,sp} = N_{Rd,c}^0 \cdot f_B \cdot f_{1,sp} \cdot f_{2,sp} \cdot f_{3,sp} \cdot f_{h,sp} \cdot f_{re,N}$

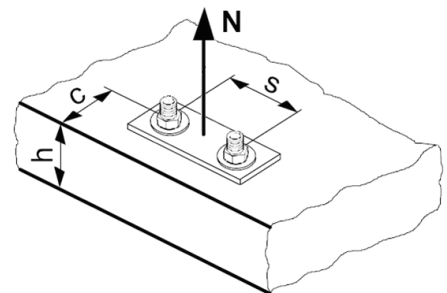

Basic design tensile resistance

Design steel resistance $N_{Rd,s}$

Anchor size	M6	M8	M10	M12	M16	M20
$N_{Rd,s}$ HSA-F [kN]	6,4	11,8	20,0	29,6	59,0	88,5

Design pull-out resistance $N_{Rd,p} = N_{Rd,p}^0$

Anchor size	M6		M8			M10			
Effective anchorage depth h_{ef} [mm]	30	40	30	40	70	40	50	80	
$N_{Rd,p}^0$ HSA-F [kN]	4,0	5,0	No pull-out			10,7	No pull-out	10,7	13,3

Anchor size	M12			M16			M20		
Effective anchorage depth h_{ef} [mm]	50	65	100	65	80	120	75	100	115
$N_{Rd,p}^0$ HSA-F [kN]	No pull-out	16,7	16,7	13,3	20,0	26,7	No pull-out		

Design concrete cone resistance $N_{Rd,c} = N_{Rd,c}^0 \cdot f_B \cdot f_{1,N} \cdot f_{2,N} \cdot f_{3,N} \cdot f_{re,N}$

Design splitting resistance ^{a)} $N_{Rd,sp} = N_{Rd,c}^0 \cdot f_B \cdot f_{1,sp} \cdot f_{2,sp} \cdot f_{3,sp} \cdot f_{h,sp} \cdot f_{re,N}$

Anchor size			M6		M8			M10		
Effective anchorage depth	h_{ef}	[mm]	30	40	30	40	70	40	50	80
$N_{Rd,p}^0$	HSA-F	[kN]	5,5	8,5	5,5	8,5	19,7	8,5	11,9	24,1

Anchor size			M12			M16			M20		
Effective anchorage depth	h_{ef}	[mm]	50	65	100	65	80	120	75	100	115
$N_{Rd,p}^0$	HSA-F	[kN]	11,9	17,6	33,7	17,6	24,1	44,3	21,9	33,7	41,5

Influencing factors

Influence of concrete strength

Concrete strength designation (ENV 206)	C 20/25	C 25/30	C 30/37	C 35/45	C 40/50	C 45/55	C 50/60
Pull-out, concrete cone and splitting resistance							
$f_B = (f_{ck,cube}/25N/mm^2)^{1/2}$ ^{a)}	1	1,1	1,22	1,34	1,41	1,48	1,55

a) $f_{ck,cube}$ = concrete compressive strength, measured on cubes with 150 mm side length

Influence of edge distance ^{a)}

$c/c_{cr,N}$	0,1	0,2	0,3	0,4	0,5	0,6	0,7	0,8	0,9	1
$c/c_{cr,sp}$										
$f_{1,N} = 0,7 + 0,3 \cdot c/c_{cr,N} \leq 1$	0,73	0,76	0,79	0,82	0,85	0,88	0,91	0,94	0,97	1
$f_{1,sp} = 0,7 + 0,3 \cdot c/c_{cr,sp} \leq 1$										
$f_{2,N} = 0,5 \cdot (1 + c/c_{cr,N}) \leq 1$	0,55	0,60	0,65	0,70	0,75	0,80	0,85	0,90	0,95	1
$f_{2,sp} = 0,5 \cdot (1 + c/c_{cr,sp}) \leq 1$										

a) The edge distance shall not be smaller than the minimum edge distance c_{min} given in the table with the setting details. These influencing factors must be considered for every edge distance.

Influence of anchor spacing ^{a)}

$s/s_{cr,N}$	0,1	0,2	0,3	0,4	0,5	0,6	0,7	0,8	0,9	1
$s/s_{cr,sp}$										
$f_{3,N} = 0,5 \cdot (1 + s/s_{cr,N}) \leq 1$	0,55	0,60	0,65	0,70	0,75	0,80	0,85	0,90	0,95	1
$f_{3,sp} = 0,5 \cdot (1 + s/s_{cr,sp}) \leq 1$										

a) The anchor spacing shall not be smaller than the minimum anchor spacing s_{min} given in the table with the setting details. This influencing factor must be considered for every anchor spacing.

Influence of base material thickness

h/h_{min}	1,0	1,1	1,2	1,3	1,4	1,5	1,6	1,7	1,8	$\geq 1,84$
$f_{h,sp} = [h/(h_{min})]^{2/3}$	1	1,07	1,13	1,19	1,25	1,31	1,37	1,42	1,48	1,5

Influence of reinforcement ^{a)}

Anchor size	M6			M8			M10		
Effective anchorage depth h_{ef} [mm]	30	40		30	40	70	40	50	80
$f_{re,N} = 0,5 + h_{ef}/200\text{mm} \leq 1$	0,65	0,7		0,65	0,7	0,85	0,7	0,75	0,9

Anchor size	M12			M16			M20		
Effective anchorage depth h_{ef} [mm]	50	65	100	65	80	120	75	100	115
$f_{re,N} = 0,5 + h_{ef}/200\text{mm} \leq 1$	0,75	0,83	1	0,83	0,9	1	0,88	1	1

b) This factor applies only for dense reinforcement. If in the area of anchorage there is reinforcement with a spacing ≥ 150 mm (any diameter) or with a diameter ≤ 10 mm and a spacing ≥ 100 mm, then a factor $f_{re,N} = 1$ may be applied.

Shear loading

The design shear resistance is the lower value of

- Steel resistance: $V_{Rd,s}$
- Concrete pryout resistance: $V_{Rd,cp} = k \cdot N_{Rd,c}$
- Concrete edge resistance: $V_{Rd,c} = V_{Rd,c}^0 \cdot f_B \cdot f_{\beta} \cdot f_h \cdot f_4 \cdot f_{hef} \cdot f_c$

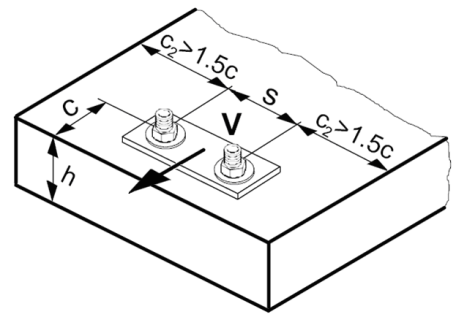

Basic design shear resistance

Design steel resistance $V_{Rd,s}$

Anchor size	M6	M8	M10	M12	M16	M20
$V_{Rd,s}$ HSA-F [kN]	5,2	8,5	15,1	23,6	40,8	68,6

Design concrete pryout resistance $V_{Rd,cp} = k \cdot N_{Rd,c}$ ^{a)}

Anchor size	M6			M8			M10		
Effective anchorage depth h_{ef} [mm]	30	40		30	40	70	40	50	80
k	1	1		1	1,5	2	2,4	2,4	2,4

Anchor size	M12			M16			M20		
Effective anchorage depth h_{ef} [mm]	50	65	100	65	80	120	75	100	115
k	2	2	2	2,9	2,9	2,9	2	3,5	3,5

a) $N_{Rd,c}$: Design concrete cone resistance

Design concrete edge resistance ${}^a)V_{Rd,c} = V_{Rd,c}^0 \cdot f_B \cdot f_{\beta} \cdot f_h \cdot f_4 \cdot f_{hef} \cdot f_c$

Anchor size	M6			M8			M10		
Effective anchorage depth h_{ef} [mm]	30	40		30	40	70	40	50	80
$V_{Rd,c}^0$ [kN]	3,6	3,6		5,8	5,9	6,0	8,5	8,5	8,6

Anchor size	M12			M16			M20		
Effective anchorage depth h_{ef} [mm]	50	65	100	65	80	120	75	100	115
$V_{Rd,c}^0$ [kN]	11,6	11,6	11,7	18,7	18,8	18,9	27,2	27,3	27,4

b) For anchor groups only the anchors close to the edge must be considered.

Influencing factors

Influence of concrete strength

Concrete strength designation (ENV 206)	C 20/25	C 25/30	C 30/37	C 35/45	C 40/50	C 45/55	C 50/60
$f_B = (f_{ck,cube}/25N/mm^2)^{1/2}$ a)	1	1,1	1,22	1,34	1,41	1,48	1,55

a) $f_{ck,cube}$ = concrete compressive strength, measured on cubes with 150 mm side length

Influence of angle between load applied and the direction perpendicular to the free edge

Angle β	0°	10°	20°	30°	40°	50°	60°	70°	80°	≥ 90°
$f_{\beta} = \frac{1}{\sqrt{(\cos \alpha_V)^2 + \left(\frac{\sin \alpha_V}{2,5}\right)^2}}$	1	1,01	1,05	1,13	1,24	1,40	1,64	1,97	2,32	2,50

Influence of base material thickness

h/c	0,15	0,3	0,45	0,6	0,75	0,9	1,05	1,2	1,35	≥ 1,5
$f_h = \{h/(1,5 \cdot c)\}^{1/2} \leq 1$	0,32	0,45	0,55	0,63	0,71	0,77	0,84	0,89	0,95	1,00

Influence of anchor spacing and edge distance ^{a)} for concrete edge resistance: f_4

$$f_4 = (c/h_{ef})^{1,5} \cdot (1 + s / [3 \cdot c]) \cdot 0,5$$

c/h _{ef}	Single anchor	Group of two anchors s/h _{ef}														
		0,75	1,50	2,25	3,00	3,75	4,50	5,25	6,00	6,75	7,50	8,25	9,00	9,75	10,50	11,25
0,50	0,35	0,27	0,35	0,35	0,35	0,35	0,35	0,35	0,35	0,35	0,35	0,35	0,35	0,35	0,35	0,35
0,75	0,65	0,43	0,54	0,65	0,65	0,65	0,65	0,65	0,65	0,65	0,65	0,65	0,65	0,65	0,65	0,65
1,00	1,00	0,63	0,75	0,88	1,00	1,00	1,00	1,00	1,00	1,00	1,00	1,00	1,00	1,00	1,00	1,00
1,25	1,40	0,84	0,98	1,12	1,26	1,40	1,40	1,40	1,40	1,40	1,40	1,40	1,40	1,40	1,40	1,40
1,50	1,84	1,07	1,22	1,38	1,53	1,68	1,84	1,84	1,84	1,84	1,84	1,84	1,84	1,84	1,84	1,84
1,75	2,32	1,32	1,49	1,65	1,82	1,98	2,15	2,32	2,32	2,32	2,32	2,32	2,32	2,32	2,32	2,32
2,00	2,83	1,59	1,77	1,94	2,12	2,30	2,47	2,65	2,83	2,83	2,83	2,83	2,83	2,83	2,83	2,83
2,25	3,38	1,88	2,06	2,25	2,44	2,63	2,81	3,00	3,19	3,38	3,38	3,38	3,38	3,38	3,38	3,38
2,50	3,95	2,17	2,37	2,57	2,77	2,96	3,16	3,36	3,56	3,76	3,95	3,95	3,95	3,95	3,95	3,95
2,75	4,56	2,49	2,69	2,90	3,11	3,32	3,52	3,73	3,94	4,15	4,35	4,56	4,56	4,56	4,56	4,56
3,00	5,20	2,81	3,03	3,25	3,46	3,68	3,90	4,11	4,33	4,55	4,76	4,98	5,20	5,20	5,20	5,20
3,25	5,86	3,15	3,38	3,61	3,83	4,06	4,28	4,51	4,73	4,96	5,18	5,41	5,63	5,86	5,86	5,86
3,50	6,55	3,51	3,74	3,98	4,21	4,44	4,68	4,91	5,14	5,38	5,61	5,85	6,08	6,31	6,55	6,55
3,75	7,26	3,87	4,12	4,36	4,60	4,84	5,08	5,33	5,57	5,81	6,05	6,29	6,54	6,78	7,02	7,26
4,00	8,00	4,25	4,50	4,75	5,00	5,25	5,50	5,75	6,00	6,25	6,50	6,75	7,00	7,25	7,50	7,75
4,25	8,76	4,64	4,90	5,15	5,41	5,67	5,93	6,18	6,44	6,70	6,96	7,22	7,47	7,73	7,99	8,25
4,50	9,55	5,04	5,30	5,57	5,83	6,10	6,36	6,63	6,89	7,16	7,42	7,69	7,95	8,22	8,49	8,75
4,75	10,35	5,45	5,72	5,99	6,27	6,54	6,81	7,08	7,36	7,63	7,90	8,17	8,45	8,72	8,99	9,26
5,00	11,18	5,87	6,15	6,43	6,71	6,99	7,27	7,55	7,83	8,11	8,39	8,66	8,94	9,22	9,50	9,78
5,25	12,03	6,30	6,59	6,87	7,16	7,45	7,73	8,02	8,31	8,59	8,88	9,17	9,45	9,74	10,02	10,31
5,50	12,90	6,74	7,04	7,33	7,62	7,92	8,21	8,50	8,79	9,09	9,38	9,67	9,97	10,26	10,55	10,85

- a) The anchor spacing and the edge distance shall not be smaller than the minimum anchor spacing s_{min} and the minimum edge distance c_{min} .

Influence of embedment depth

Anchor size	M6		M8			M10		
Effective anchorage depth h_{ef} [mm]	30	40	30	40	70	40	50	80
$f_{hef} = 0,05 \cdot (h_{ef} / d)^{1,68}$	0,75	1,21	0,46	0,75	1,91	0,51	0,75	1,64

Anchor size	M12			M16			M20		
Effective anchorage depth h_{ef} [mm]	50	65	100	65	80	120	75	100	115
$f_{hef} = 0,05 \cdot (h_{ef} / d)^{1,68}$	0,55	0,85	1,76	0,53	0,75	1,48	0,46	0,75	0,94

Influence of edge distance ^{a)}

c/d	4	6	8	10	15	20	30	40
$f_c = (d / c)^{0,19}$	0,77	0,71	0,67	0,65	0,60	0,57	0,52	0,50

- a) The edge distance shall not be smaller than the minimum edge distance c_{min} .

Combined tension and shear loading

For combined tension and shear loading see section "Anchor Design".